



Panama

LED ceiling lamp IP66. Suitable for illuminating warehouse and open space indoor/outdoor areas. Polycarbonate frame and diffuser, bypass wiring, steel closing hooks.

Code	6931-64-954
Type	Outdoor Ceiling Light
Designer	S.T. Fabas Luce
Eancode	8019282506300
Customs tariff	94051140
Color	Grey
Material	Polycarbonate
IP	IP66
IK	08
Insulation Class	 CL1
Operating ambient temperature	-20°C+35°C
Years of warranty	3
Item Dimensions	1220x100x83mm - 2.3kg
Packaging Dimensions	1590x90x90mm - 2.7kg
	Light Source 1
Light source	LED Built-in
LED Characteristics	SMD
Light Source Lumen	6686 lm
Item Lumen	5850 lm
Color Temperature	Natural white 4000 K
Optics	Diffused beam
Minimum CRI	>80
Luminous Flux Maintenance	50.000h L70 B50
Energy Efficiency Class	
	Electrical specifications 1
Input Voltage	220/240V AC 50/60Hz
Total Absorbed Power	45W
Driver	Included
Power Factor	> 0.9
Control System	On/Off

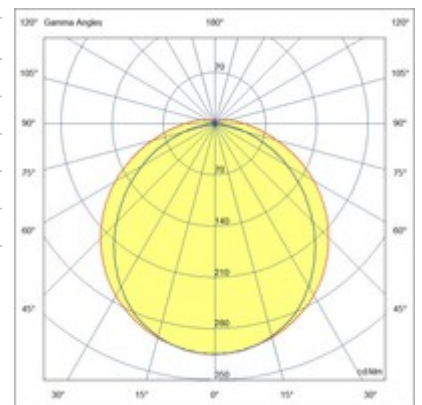
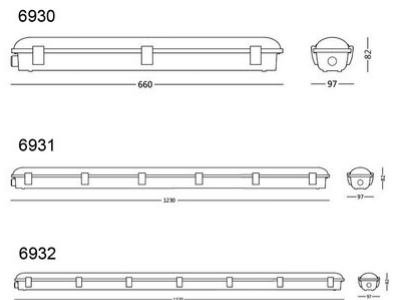

CE