



2024 · 2025
Decorative Lighting

Life & Light Evolution

Life evolution

Fabbas
L U C E



Un assortimento rinnovato di prodotti tecnici dove ogni articolo è stato progettato e sviluppato con attenzione, combinando le tecnologie più avanzate con un design raffinato ed elegante. Ma l'evoluzione non riguarda solo la nostra offerta tecnica.

Siamo lieti di presentarvi anche il restyling del nostro logo aziendale, un simbolo che rappresenta il nostro percorso di crescita, di cambiamento e sviluppo. Il nuovo logo riflette la nostra identità rinnovata, mantenendo intatti i valori di qualità, passione, affidabilità e innovazione che ci hanno sempre contraddistinto.

A renewed range of technical products where every item has been engineered and carefully developed, combining the most advanced technologies with a refined and elegant design. But evolution does not only concern our technical offer.

We are pleased to introduce you also the restyling of our company logo, a symbol that represents our path of growth, change and development. The new logo reflects our identity renewed, keeping intact quality values, reliability and innovation that they have always distinguished us.

Light evolution



L'evoluzione della luce è nella rinnovata varietà di prodotti che segna un punto di svolta per la nostra azienda, un progetto che incarna la continua ricerca di eccellenza e innovazione.

Questa nuova visione porta alla realizzazione di due cataloghi coordinati e complementari per una illuminazione a 360°: **decorativa e tecnica.**

The evolution of light lies in the renewed variety of products that marks a turning point for our company, a project that embodies the continuous search for excellence and innovation.

This new vision leads to the creation of two coordinated and complementary catalogues for all-around lighting: **decorative and technical.**



Innovation meets sustainability



La nostra azienda crede nell'importanza del rispetto per l'ambiente ed è per questo che ha deciso di introdurre nuovi cambiamenti per la sua salvaguardia. Ecco come:

- PACKAGING

A partire dai nuovi modelli e con un processo che toccherà rapidamente anche i prodotti già in produzione, gli imballi saranno realizzati con cartone riciclato o riciclabile, privilegiando l'utilizzo di carta.

Ove non sia possibile verranno utilizzate soltanto plastiche riciclabili, mentre i cartoni usati vengono già riciclati e triturati utilizzandoli come riempimento dei cartoni master per le spedizioni evitando quindi l'utilizzo di bolle aria in plastica.

- PEZZI DI RICAMBIO

La nostra azienda assicura i pezzi di ricambio dei propri prodotti aumentandone la vita media e rimandando lo smaltimento del prodotto.

- IMPIANTO FOTOVOLTAICO

La nostra sede di Brugherio è interamente alimentata da pannelli fotovoltaici che permettono di evitare emissioni annuali di oltre 30 tonnellate di CO₂ un equivalente di 1.411 nuovi alberi piantati.

Our company believes in the importance of respecting the environment and this is why it has decided to introduce new changes to safeguard it. Here's how:

- PACKAGING

Already started with the new models and in a process that will quickly touch products already in production, packaging will be made from recycled or recyclable cardboard favoring the use of paper.

Where this is not possible, only recyclable plastic components will be used, while the used cartons are already recycled and shredded using them as filler for the master cartons for shipments, thus avoiding the use of plastic air bubbles.

- SPARE PARTS

Our company ensures spare parts for its products by increasing their average life and postponing product disposal.

- PHOTOVOLTAIC PLANT

Our Headquarter in Brugherio is entirely powered by photovoltaic panels, which avoids annual emissions of more than 30 tons of CO₂ as equivalent of 1.411 new trees planted.



Emissioni di CO₂ evitate
Avoided CO₂ emissions

30,73 t



Alberi Equivalenti piantati
Equivalent trees planted

1.411



Sempre attenti alla scelta di materiali naturali, oltre a legno, vetro, ceramica, la gamma di prodotti si arricchisce della plastica vegetale PLA: per condividere la scelta sostenibile di Fabas, basta cercare il bollino PLA sul catalogo.

**Carola,
Cone,
Lisa e
Nadine:**



Le nostre lampade sostenibili realizzate in stampa 3D, uniscono forme eleganti e funzionalità, rispettando l'ambiente in quanto realizzate con plastica vegetale PLA.

Scegliendo le nuove lampade PLA contribuirete a promuovere un'economia circolare, riducendo la dipendenza dalle risorse non rinnovabili grazie a un design duraturo e più leggero per l'ambiente.

I vantaggi del PLA:

- proviene da fonti rinnovabili dell'industria alimentare
- è compostabile
- capacità di degradarsi in modo naturale nel tempo
- riduce l'impatto ambientale rispetto alla plastica tradizionale
- progettato e prodotto in Italia

Consistently opting for natural materials, in addition to wood, glass, ceramic, our product range is now enhanced with PLA plant-based plastic: to share the sustainable choice of Fabas, simply look for the PLA sticker in the catalogue.

**Carola,
Cone,
Lisa and
Nadine:**

Our sustainable 3D-printed lamps combine elegant shapes with functionality while respecting the environment, as they are made of PLA plant-based plastic.

By choosing our new PLA lamps, you will help to promote a circular economy, thus reducing dependence on non-renewable resources thanks to a long-lasting and more eco-friendly design.

The advantages of PLA:

- it comes from renewable sources in the food industry
- it is compostable
- it has the ability to degrade naturally over time
- it reduces the environmental impact compared to traditional plastic
- it is designed and manufactured in Italy

Upgrade your style!



Fabas Luce continua a evolversi con il lancio del nuovo catalogo. Abbiamo posto particolare attenzione alla presentazione dei nostri prodotti, ampliando il numero di ambienti in cui le nostre lampade sono inserite. Accresciamo l'attenzione per i dettagli, i materiali impiegati e i miglioramenti tecnici come i nuovi rosoni, il cambio temperatura colore nei circuiti LED e le nuove funzionalità delle piantane LED. Questo approccio mette in risalto ogni singolo modello, offrendo una visione completa e affascinante. Il risultato è un catalogo che non solo esibisce la bellezza e la qualità delle nostre soluzioni di illuminazione, ma lo fa in modo coinvolgente e pratico, pensato per ispirare e soddisfare le esigenze di ogni cliente.

Fabas Luce continues to evolve with the release of our new catalogue. We have placed particular emphasis on showcasing our products, expanding the number of environments in which our lamps are featured. We have heightened our focus on details, materials used, and technical enhancements such as the new ceiling cups, color temperature adjustment in LED circuits, and the new functionalities of LED floor lamps. This approach highlights every individual model, providing a comprehensive and captivating view. The result is a catalogue that not only displays the beauty and quality of our lighting solutions but does so in an engaging and practical manner, designed to inspire and meet the needs of every customer.



suspension



ceiling lamp



wall lamp



wall lamp IP 44



table lamp



floor lamp

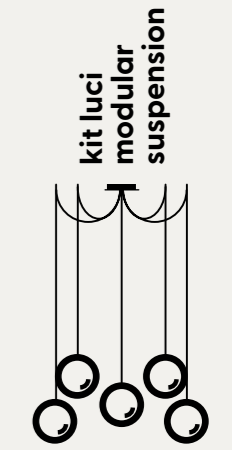

kit luci modular suspension

Il nuovo catalogo decorativo di Fabas Luce è stato progettato per offrire un'esperienza di consultazione intuitiva e funzionale. I prodotti sono organizzati per applicazione, con collegamenti diretti alle proposte complementari della stessa collezione, semplificando così la selezione e la combinazione degli articoli.

The new Fabas Luce decorative catalogue is designed to offer an intuitive and functional browsing experience. Products are organized by application, with direct links to complementary proposals within the same collection, making it easier to select and combine items.



Kit Luci ...evolution

Un concept versatile, creativo, contemporaneo e sostenibile. Crea la tua sospensione personalizzata con il nostro innovativo sistema modulare KIT LUCI, che offre **oltre 4000 combinazioni possibili!**

Il sistema modulare si divide in due categorie di prodotti: KIT LUCI EDISON
KIT LUCI LED

A versatile, creative, contemporary and sustainable concept! Create your own customized suspension with our innovative KIT LUCI modular system, which offers **over 4000 possible combinations!**

The modular system is divided into two product categories: KIT LUCI EDISON
KIT LUCI LED



**KIT LUCI
LED**

KIT LUCI EDISON

1. Scegli il rosone
2. Scegli il vetro (che include il portalampada e il cavo lungo 3,5 metri)
3. Crea la tua sospensione

Per le sospensioni con lampadina E27 o E14, puoi scegliere:

- Diverse forme di vetro già fornite con il portalampada e il cavo di 3,5 metri.
- La tipologia di rosone che preferisci per creare la tua sospensione.

1. Choose the ceiling cup
2. Choose the glass (which includes the lampholder and cable with a length of 3.5 meters)
3. Create your suspension

For suspensions with lampholder E27 or E14, you may choose:

- Various glass shapes already supplied with the lamp holder and the 3.5 meter cable.
- The type of ceiling cup you prefer for your suspension.



1. Scegli la montatura completa
2. Scegli il paralume di metallo o il vetro
3. Crea la tua sospensione
4. Seleziona la temperatura colore che preferisci

Per tutte le sospensioni con circuito LED integrato, puoi regolare la temperatura colore 2700K/3000K/4000K secondo le tue necessità o le tue esigenze. In questo concept puoi scegliere:

- Montature complete (esclusi vetro o parabola in metallo), disponibili in due potenze diverse, 8W e 14W.
- La tipologia di vetro e/o parabola in metallo.

1. Choose the complete frame
2. Choose the metal shade or the glass
3. Create your suspension
4. Choose your desired temperature light color

For the whole range of suspensions with integrated LED circuit, you can adjust the colour temperature 2700K/3000/4000K according to your needs or requirements. In this concept you can choose:

- Complete frame (excluding glass or metal shade), available in two different wattages, 8W and 14W.
- The type of glass and/or metal shade.

TECHNICAL INFORMATION:

Per facilitare la navigazione del catalogo lo abbiamo suddiviso in sezioni chiare e intuitive con elementi grafici fissi per la lettura delle caratteristiche tecniche del prodotto. In questa pagina una presentazione dei punti più importanti.

To make the catalogue easier to navigate, we have divided it into clear and intuitive sections with fixed graphic elements for reading the technical characteristics of the product. On this page a presentation of the most important points.



- 1 Capitolo di riferimento
Reference chapter
- 2 Nome collezione, codice di riferimento e descrizione materiali
Collection name, reference code and material description
- 3 Qui trovi i rimandi ad articoli complementari per applicazione, ma della stessa collezione
Here you will find references to complementary items for application, but in the same collection
- 4 Nome e codice collezione
Name and collection code

- 5 Disegno tecnico con quote
Technical drawing with dimensions
- 6 Tabella con caratteristiche tecniche del prodotto e tutte le informazioni necessarie alla vendita e utilizzo. I vari simboli sono spiegati nelle pagine finali del catalogo
Technical characteristics table of the product and all information necessary for sale and use. The different symbols are explained in the last pages of the catalogue

visual index

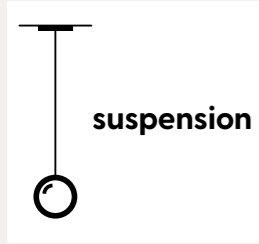

suspension



3623
apollo
PAGE 128



3547
arabella
PAGE 70



3357
aragon E27
PAGE 144



3357
aragon LED
PAGE 145



3770
ariel
PAGE 38



3383
badia
PAGE 158



3394
bard
PAGE 94



3755
brena
PAGE 30



3673
britton
PAGE 132



3677
camp
PAGE 164



3757
carola
PAGE 182



3532
casale
PAGE 174



3758
cone
PAGE 184



3697
cordoba
PAGE 152



3531
corvara
PAGE 172



3535
crumple
PAGE 180



3596
dafne
PAGE 130



3774
deva
PAGE 50



2753
diana
PAGE 146



3215
dingle
PAGE 170



3689
domizia
PAGE 140



3533
duchessa
PAGE 176



3239
dunk
PAGE 80



3489
ela
PAGE 120



3706
fassa
PAGE 160



3496
fiona
PAGE 116



3627
gillis
PAGE 138



3508
giotto
PAGE 88



3518
gisella
PAGE 136



3670
homa
PAGE 162



3519
infinity
PAGE 114



3410
isabella
PAGE 76



3767
kino
PAGE 62



3768
lapo
PAGE 66



3481
lila
PAGE 108



3712
ling
PAGE 84



3759
lisa
PAGE 186



3161
lodge
PAGE 168



3750
loto
PAGE 142



3764
lucille
PAGE 46



3800
lunar
PAGE 22



3490
maia
PAGE 118



3534
marina
PAGE 178



3681
next
PAGE 86



2908
nice
PAGE 151



3772
noa
PAGE 54



3743
palau
PAGE 98



3672
pevero
PAGE 156



3695
pierre
PAGE 155



3685
prado
PAGE 56



2907
provenza
PAGE 150



3676
ribot
PAGE 154



3491
silo
PAGE 122



3480
sintesi
PAGE 124



3666
sinuo
PAGE 106



3626
sylvie
PAGE 102



3625
vela
PAGE 104



3803
yuko
PAGE 26



2433
pandora E27
PAGE 234



3222
pandora E27 sensor
PAGE 236



3563
pandora LED
PAGE 237



2866
plaza E27
PAGE 240



3566
plaza LED
PAGE 241



3789
quirk
PAGE 194



3666
sinuo
PAGE 226



3625
vela
PAGE 230



3463
vintage
PAGE 214



3803
yuko
PAGE 204



3357
aragon LED
PAGE 212



3394
bard
PAGE 216



3755
brena
PAGE 202



3798
conrad
PAGE 192



3706
fassa
PAGE 228



2385
fox E27
PAGE 242



3564
fox LED
PAGE 243



3508
giotto
PAGE 224



3209
graff E27
PAGE 232



3414
adria
PAGE 302



3708
alide
PAGE 254



3383
badia
PAGE 291



3618
banny
PAGE 260



3567
graff LED
PAGE 233



2958
hill
PAGE 246



3788
isy
PAGE 198



3767
kino
PAGE 206



3481
lila
PAGE 208



3394
bard
PAGE 268



3697
cordoba
PAGE 290



2523
dedalo
PAGE 294



3689
domizia
PAGE 295



3717
dual
PAGE 308



3800
lunar
PAGE 190



2957
maggie
PAGE 244



3521
magma
PAGE 247



2867
osaka E27
PAGE 238



3565
osaka LED
PAGE 239



3239
dunk
PAGE 282



3506
emma
PAGE 278



2385
fox E27
PAGE 305



3508
giotto
PAGE 272



3417
goodnight
PAGE 310

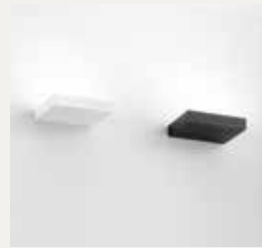

3799
guia
PAGE 256



2958
hill
PAGE 298



3663
linus
PAGE 288



3690
loft
PAGE 284



3559
lotus
PAGE 266

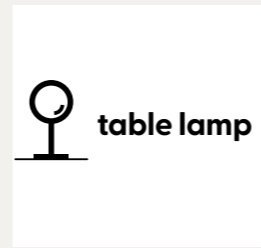

table lamp



2533
ade
PAGE 398



3414
adria
PAGE 378



3770
ariel
PAGE 340



3394
bard
PAGE 376

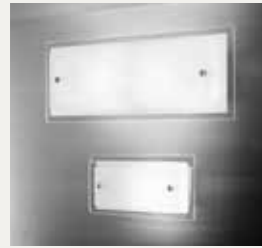

2957
maggie
PAGE 297



3521
magma
PAGE 304



3707
maribel
PAGE 252



3253
mill
PAGE 276



3113
milton
PAGE 299



3775
beba
PAGE 354



3790
blip
PAGE 330



3509
bluma
PAGE 406



3755
brena
PAGE 342



3407
brenta
PAGE 380



3249
moa
PAGE 301



2433
pandora E27
PAGE 296



3672
pevero
PAGE 287



3551
regina
PAGE 274



3558
regolo
PAGE 264



3677
camp
PAGE 370



3689
domizia
PAGE 352



3761
elea
PAGE 346



3792
flick
PAGE 326



3752
freddy
PAGE 338



3676
ribot
PAGE 286



3715
roseg
PAGE 306



3177
slane
PAGE 300



3523
sunrise
PAGE 280



2899
vanity
PAGE 303



3569
gaia
PAGE 392



2654
gaia big
PAGE 393



3518
gisella
PAGE 367



3360
gravity
PAGE 382



3703
ibla
PAGE 348



3682
viki
PAGE 250



3471
window
PAGE 292



wall lamp
IP44



3720
ago
PAGE 322



2642
dedalo
PAGE 321



3550
ideal
PAGE 358



3519
infinity
PAGE 368



3339
jap
PAGE 386



3568
lucy
PAGE 390



2653
lucy big
PAGE 391



3431
iglesias
PAGE 320



3361
nala
PAGE 314



3552
rapallo
PAGE 318



3527
marbella
PAGE 400



3754
micky
PAGE 344



3528
micol
PAGE 401



3576
milady
PAGE 396



3570
morgana
PAGE 394



3760
nadine
PAGE 402



3386
neutra
PAGE 372



3675
panarea
PAGE 362



3695
pierre
PAGE 366



3551
regina
PAGE 356



3786
tratto
PAGE 414



3625
vela
PAGE 430



3571
rockford
PAGE 387



3257
simi
PAGE 384



3644
sveva
PAGE 364



3511
thalia
PAGE 404



3625
vela
PAGE 374



3783
victoria
PAGE 350



3265
wasp
PAGE 360



3762
wendy
PAGE 336



3763
wilma
PAGE 334



3579
zara
PAGE 388

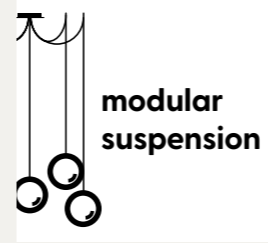

kit luci LED
PAGE 444



frame LED 8W
PAGE 446



lampshade 8W
PAGE 448



lampshade 8W
PAGE 450



frame LED 14W
PAGE 452



lampshade 14W
PAGE 454



lampshade 14W
PAGE 456

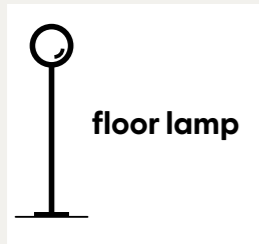

3775
beba
PAGE 418



3697
cordoba
PAGE 436



3689
domizia
PAGE 440



3807
fizz
PAGE 410



kit luci EDISON
PAGE 458



frame
PAGE 460



glass
PAGE 462



3550
ideal
PAGE 420



3712
ling
PAGE 438



3750
loto
PAGE 432



3551
regina
PAGE 424



3644
sveva
PAGE 434

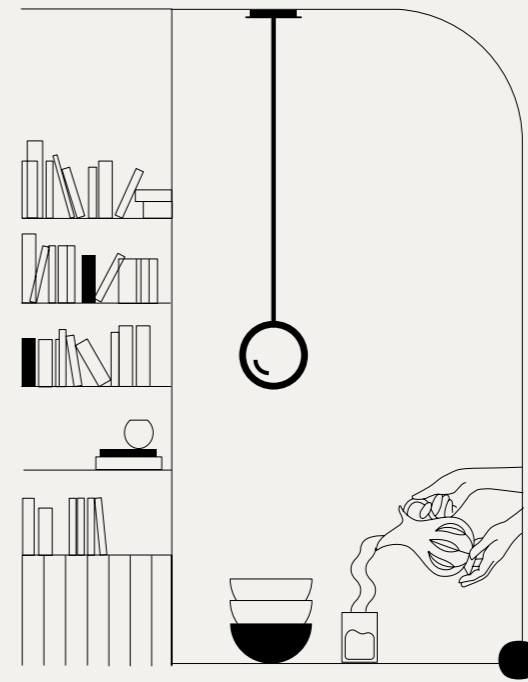

suspension

3800

Struttura in metallo e vetro soffiato - Metal frame and blown glass
Monture en métal et verre soufflé - Metallgestell und geblasenes Glas



suspension



lunar 3800

Noir - Schwarz  Blanc - Weiss 



suspension



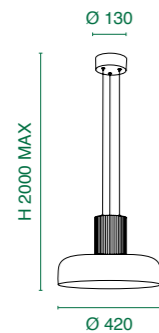

Modalità semplice per selezionare la temperatura colore.
Simple way to select the color temperature.
Un moyen simple de sélectionner la température de couleur.
Einfache Möglichkeit, die Farbtemperatur auszuwählen.



LED Warm white - Natural white 26W - 3150 lm

3800-40-101  Nero - Black

3800-40-102  Bianco - White

 Dimmerabile a step
Steps dimmable
Gradable
In Stufen dimmbar

 2700K - 3000K - 4000K

CE   IP20



Lumar 3800

Struttura in metallo e metacrilato - Metal and methacrylate frame
Monture en métal et méthacrylate - Metall- und Methacrylatgestell

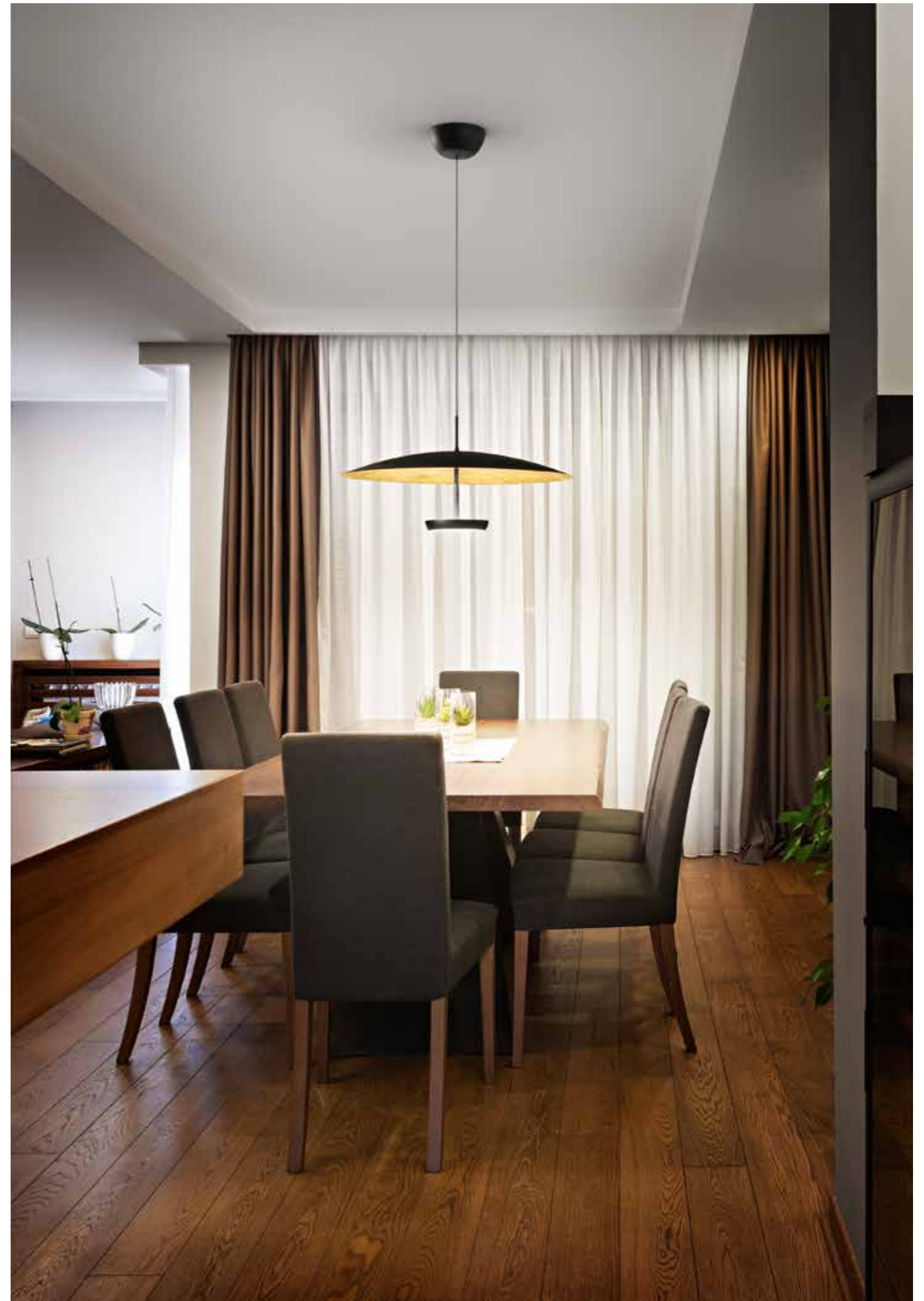

- Feville or/Noir - Blattgold/Schwarz
- Blanc - Weiss

suspension

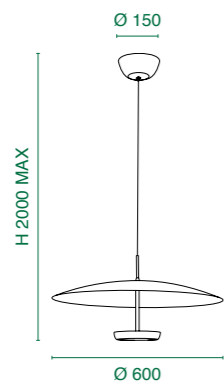

LED Warm white 3000K - 40W - 3200 lm

3803-45-102 Bianco - White

3803-45-294 Foglia oro/Nero - Gold leaf/Black

Dimmerabile a step
Steps dimmable
Gradable
In Stufen dimmbar

CE IP20 AT G

yuko 3803

Struttura in metallo e vetro borosilicato - Metal frame and borosilicate glass
 Monture en métal et verre borosilicaté - Metall und Borsilicatglas

collection:

page
202

page
342



suspension

Semplice regolazione della lunghezza del cavo grazie al meccanismo saliscendi.
 Simple cable length adjustment thanks to the up-and-down mechanism.
 Réglage simple de la longueur du câble grâce au mécanisme monte et baisse.
 Einfache Einstellung der Kabellänge dank des Auf- und Abwärtsmechanismus.



Modalità semplice per selezionare la temperatura colore.
 Simple way to select the color temperature.
 Un moyen simple de sélectionner la température de couleur.
 Einfache Möglichkeit, die Farbtemperatur auszuwählen.

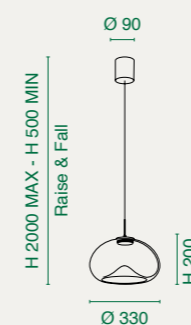

LED Warm white - Natural white 14W - 1510 lm

3755-45-241 Trasparente - Transparent

3755-45-365 Cognac

Dimmerabile a step
 Steps dimmable
 Gradable
 In Stufen dimmbar

2700K - 3000K - 4000K

CE IP20

E

Transparent   Cognac

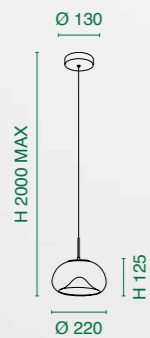
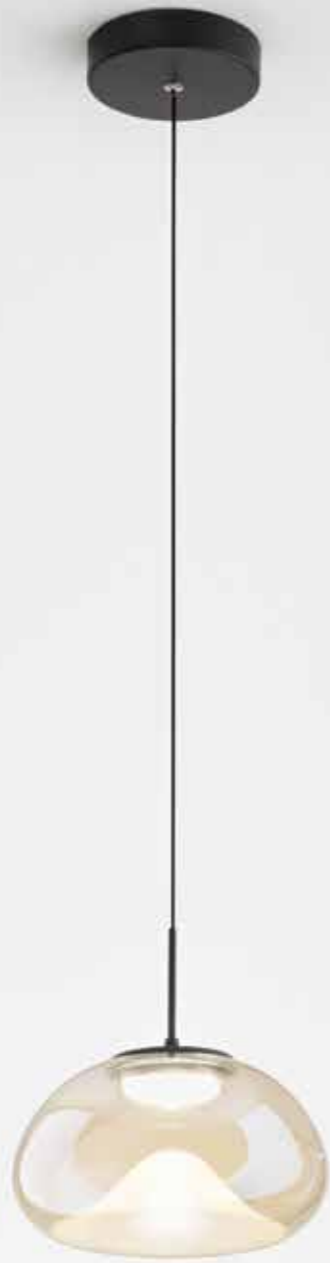

LED Warm white - Natural white 10W - 1080 lm

3755-41-241 Trasparente - Transparent

3755-41-365 Cognac

 Dimmerabile a step
Steps dimmable
Gradable
In Stufen dimmbar

 2700K - 3000K - 4000K

CE   IP20

 E

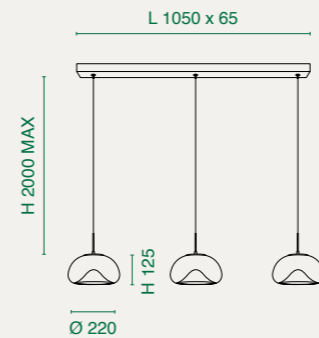



LED Warm white - Natural white 30W - 3240 lm

3755-48-241 Trasparente - Transparent

3755-48-365 Cognac

 Dimmerabile a step
Steps dimmable
Gradable
In Stufen dimmbar

 2700K - 3000K - 4000K

CE   IP20

 E

Transparent Cognac

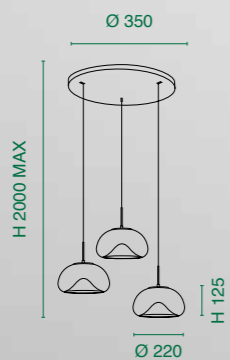

LED Warm white - Natural white 30W - 3240 lm

3755-47-241 Trasparente - Transparent

3755-47-365 Cognac

Dimmerabile a step
Steps dimmable
Gradable
In Stufen dimmbar

2700K - 3000K - 4000K

CE   IP20

 E

NEW
CURVED
FRAME



Per queste sospensioni è stato realizzato un nuovo rosone dalle dimensioni contenute e con viti invisibili.
These suspensions have a new canopy of small dimensions and invisible screws.
Ces suspensions ont une nouvelle plafond de petites dimensions et avec vis invisibles.
Diese Aufhängungen haben eine neue Deckenbaldachin mit kleinen Abmessungen und unsichtbaren Schrauben.





Transparent Cognac

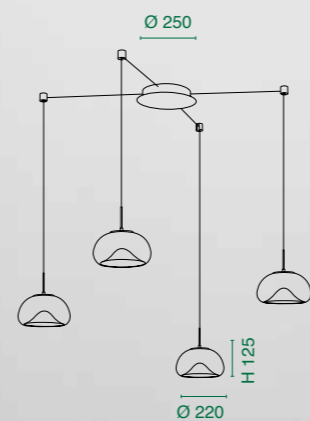

LED Warm white - Natural white 40W - 4320 lm

3755-49-241 Trasparente - Transparent

3755-49-365 Cognac

Dimmerabile a step
Steps dimmable
Gradable
In Stufen dimmbar

2700K - 3000K - 4000K

Lunghezza di ogni cavo 3500 mm
Length of each cable 3500 mm
Longueur de chaque cable 3500 mm
Kabellänge je 3500 mm

CE

E



suspension

Transparent goutte - Transparent Tropfen Transparent assorti - Transparent gemischt

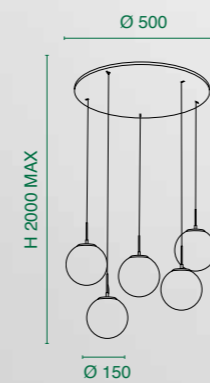

LED Warm white - Natural white 35W - 3750 lm

3770-49-372 Trasparente/goccia
 Transparent/drop



3770-49-373 Trasparente/assortiti
 Transparent/assorted

Dimmerabile a step
 Steps dimmable
 Gradable
 In Stufen dimmbar

2700K - 3000K - 4000K

CE

E

Transparent goutte - Transparent Tropfen   Transparent assorti - Transparent gemischt



LED Warm white - Natural white 21W - 2250 lm

3770-47-372  Trasparente/goccia
Transparent/drop

3770-47-373  Trasparente/assortiti
Transparent/assorted

 Dimmerabile a step
Steps dimmable
Gradable
In Stufen dimmbar

 2700K - 3000K - 4000K

CE   IP20

 E

**NEW
CURVED
FRAME**



Per queste sospensioni è stato realizzato un nuovo rosone dalle dimensioni contenute e con viti invisibili.

These suspensions have a new canopy of small dimensions and invisible screws.

Ces suspensions ont une nouvelle plafond de petites dimensions et avec vis invisibles.

Diese Aufhängungen haben eine neue Deckenbaldachin mit kleinen Abmessungen und unsichtbaren Schrauben.



Modalità semplice per selezionare la temperatura colore.

Simple way to select the color temperature.

Un moyen simple de sélectionner la température de couleur.

Einfache Möglichkeit, die Farbtemperatur auszuwählen.

Transparent goutte - Transparent Tropfen

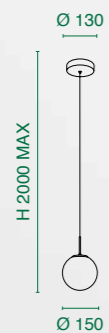

LED Warm white - Natural white 8W - 750 lm

3770-40-372 Trasparente/goccia
Transparent/drop

Dimmerabile a step
Steps dimmable
Gradable
In Stufen dimmbar

2700K - 3000K - 4000K

CE IP20

E



LED Warm white - Natural white 14W - 1510 lm

3770-45-372 Trasparente/goccia
Transparent/drop

Dimmerabile a step
Steps dimmable
Gradable
In Stufen dimmbar

2700K - 3000K - 4000K

CE IP20

E



Transparent goutte - Transparent Tropfen



suspension



ariel 3770

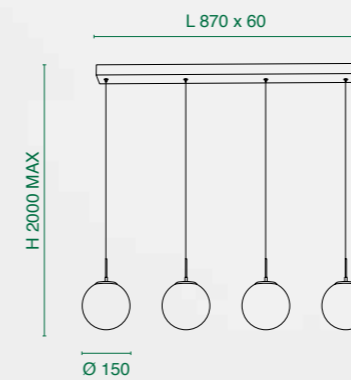



LED Warm white - Natural white 28W - 3000 lm

3770-48-372 Trasparente/goccia
Transparent/drop

Dimmerabile a step
Steps dimmable
Gradable
In Stufen dimmbar



2700K - 3000K - 4000K

CE   IP20

 E

3764

Struttura in metallo e vetro borosilicato - Metal frame and borosilicate glass
 Monture en métal et verre borosilicaté - Metall und Borsilicatglas

Gris transparent - Grau transparent   Cognac



suspension

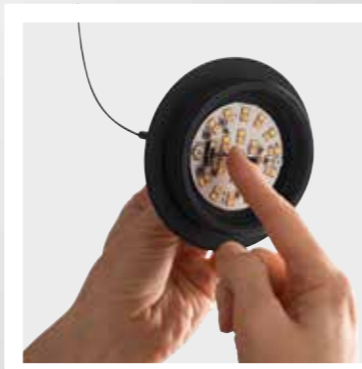
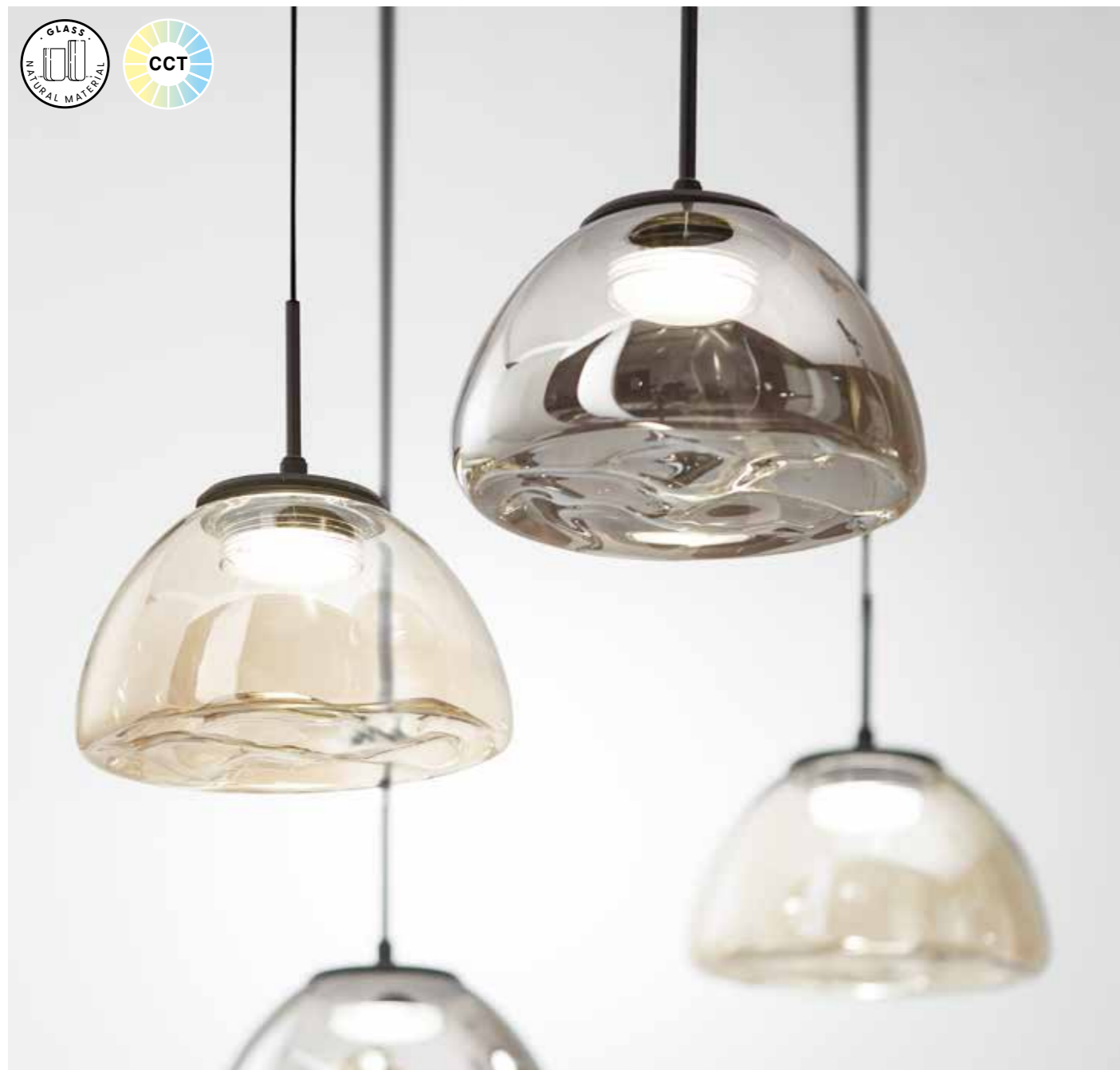

Modalità semplice per selezionare la temperatura colore.
 Simple way to select the color temperature.
 Un moyen simple de sélectionner la température de couleur.
 Einfache Möglichkeit, die Farbtemperatur auszuwählen.



Lucille 3764



LED Warm white - Natural white 8W - 750 lm

3764-41-126  Fumé - Transparent grey

3764-41-365  Cognac



Dimmerabile a step
 Steps dimmable
 Gradable
 In Stufen dimmbar

 2700K - 3000K - 4000K

CE   IP20





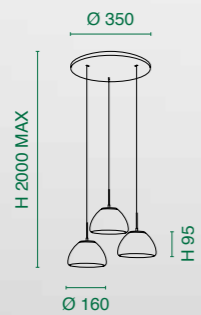

Gris transparent - Grau transparent   Cognac



LED Warm white - Natural white 21W - 2250 lm

3764-47-126  Fumé - Transparent grey

3764-47-365  Cognac

Dimmerabile a step
Steps dimmable
Gradable
In Stufen dimmbar

 2700K - 3000K - 4000K

CE   IP20



suspension



Lucille 3764

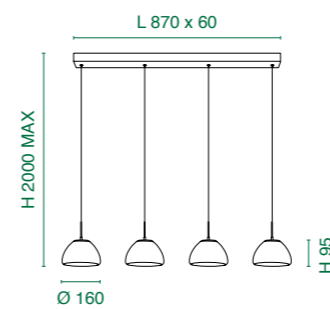



LED Warm white - Natural white 28W - 3000 lm

3764-48-126  Fumé - Transparent grey

3764-48-365  Cognac

Dimmerabile a step
Steps dimmable
Gradable
In Stufen dimmbar

 2700K - 3000K - 4000K

CE   IP20



Struttura in metallo e vetro borosilicato - Metal frame and borosilicate glass
 Monture en métal et verre borosilicaté - Metall und Borsilicatglas



suspension



Per queste sospensioni è stato realizzato un nuovo rosone dalle dimensioni contenute e con viti invisibili.
 These suspensions have a new canopy of small dimensions and invisible screws.
 Ces suspensions ont une nouvelle plafond de petites dimensions et avec vis invisibles.
 Diese Aufhängungen haben eine neue Deckenbaldachin mit kleinen Abmessungen und unsichtbaren Schrauben.



Modalità semplice per selezionare la temperatura colore.
 Simple way to select the color temperature.
 Un moyen simple de sélectionner la température de couleur.
 Einfache Möglichkeit, die Farbtemperatur auszuwählen.

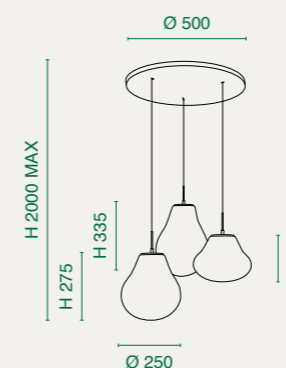

LED Warm white - Natural white 42W - 4530 lm

3774-47-125 Ambra - Amber

3774-47-126 Fumé - Transparent grey



3774-47-241 Traspirente - Transparent

Dimmerabile a step
 Steps dimmable
 Gradable
 In Stufen dimmbar

2700K - 3000K - 4000K

CE

E

Ambre - Amber  Gris transparent - Grau transparent 
Transparent 

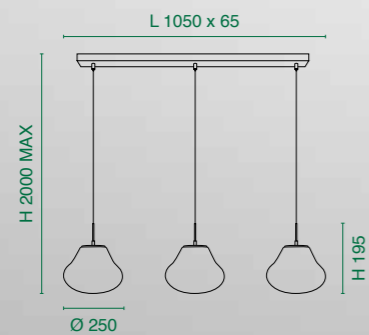



LED Warm white - Natural white 42W - 4530 lm



3774-48-125  Ambra - Amber



3774-48-126  Fumé - Transparent grey

3774-48-241  Trasparente - Transparent

 Dimmerabile a step
Steps dimmable
Gradable
In Stufen dimmbar

 2700K - 3000K - 4000K

CE   IP20 

Ambre - Amber  Gris transparent - Grau transparent 
Transparent 

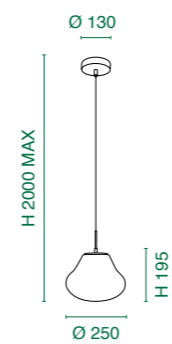



LED Warm white - Natural white 14W - 1510 lm



3774-40-125  Ambra - Amber

3774-40-126  Fumé - Transparent grey

3774-40-241  Trasparente - Transparent

 Dimmerabile a step
Steps dimmable
Gradable
In Stufen dimmbar

 2700K - 3000K - 4000K

CE   IP20 



suspension



Ambre - Amber Gris transparent - Grau transparent
 Transparent

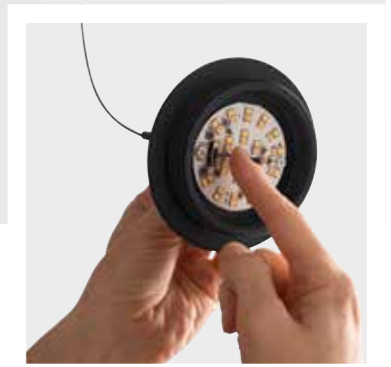

Modalità semplice per selezionare la temperatura colore.
 Simple way to select the color temperature.
 Un moyen simple de sélectionner la température de couleur.
 Einfache Möglichkeit, die Farbtemperatur auszuwählen.

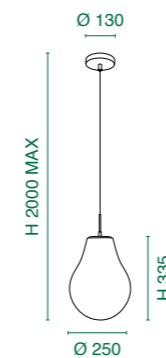

LED Warm white - Natural white 14W - 1510 lm

3772-40-125 Ambra - Amber

3772-40-126 Fumé - Transparent grey

3772-40-241 Trasparente - Transparent

Dimmerabile a step
 Steps dimmable
 Gradable
 In Stufen dimmbar

2700K - 3000K - 4000K

CE IP20

prado

Design s.t. Fabas Luce

3685

Struttura in metallo e metacrilato - Metal and methacrylate frame
 Monture en métal et méthacrylate - Metall und Methacrylat

Noir - Schwarz

Blanc - Weiss

Noir/Laiton satiné - Schwarz/Messing satiniert

suspension

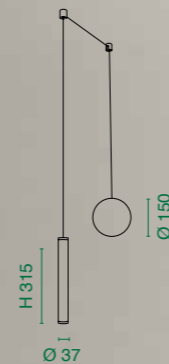

LED Warm white 3000K - 6,5W - 720 lm

3685-41-101 ■ Nero - Black

3685-41-102 □ Bianco - White



3685-41-209 ■ Nero/Ottone satinato
 Black/Satined brass

Dimmerabile a step
 Steps dimmable
 Gradable
 In Stufen dimmbar

Lunghezza cavo 5000 mm
 Length cable 5000 mm
 Longueur cable 5000 mm
 Kabellänge 5000 mm

CE IP20

E

Noir - Schwarz   Blanc - Weiss
 Noir/Laiton satiné - Schwarz/Messing satiniert 

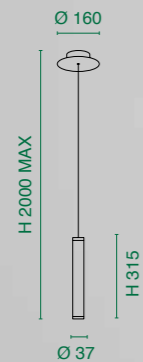

LED Warm white 3000K - 6,5W - 720 lm

3685-40-101  Nero - Black

3685-40-102  Bianco - White

3685-40-209  Nero/Ottone satinato
Black/Satined brass

 Dimmerabile a step
Steps dimmable
Gradable
In Stufen dimmbar

CE   IP20

 E

suspension

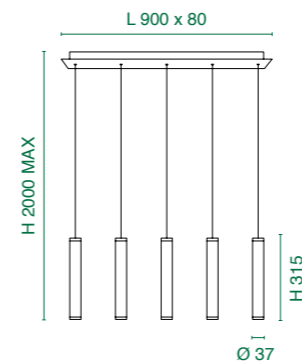



LED Warm white 3000K - 33W - 3600 lm

3685-48-101  Nero - Black





3685-48-102  Bianco - White

3685-48-209  Nero/Ottone satinato
Black/Satined brass

 Dimmerabile a step
Steps dimmable
Gradable
In Stufen dimmbar

CE   IP20

 E

Noir - Schwarz   Blanc - Weiss
 Noir/Laiton satiné - Schwarz/Messing satiniert  

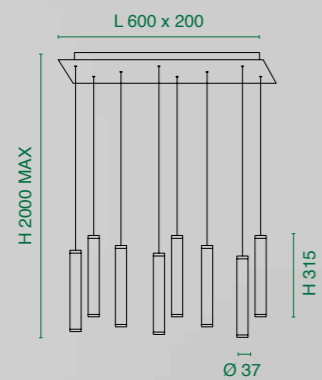

LED Warm white 3000K - 52W - 5760 lm

3685-46-101  Nero - Black

3685-46-102  Bianco - White

3685-46-209  Nero/Ottone satinato
Black/Satined brass

Dimmerabile a step
Steps dimmable
Gradable
In Stufen dimmbar

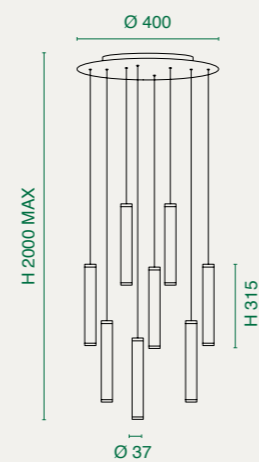

LED Warm white 3000K - 52W - 5760 lm

3685-47-101  Nero - Black

3685-47-102  Bianco - White

3685-47-209  Nero/Ottone satinato
Black/Satined brass

Dimmerabile a step
Steps dimmable
Gradable
In Stufen dimmbar



3767

Struttura in metallo e vetro borosilicato - Metal frame and borosilicate glass
 Monture en métal et verre borosilicaté - Metall und Borsilicatglas



suspension

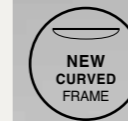

Per queste sospensioni è stato realizzato un nuovo rosone dalle dimensioni contenute e con viti invisibili.
 These suspensions have a new canopy of small dimensions and invisible screws.
 Ces suspensions ont une nouvelle plafond de petites dimensions et avec vis invisibles.
 Diese Aufhängungen haben eine neue Deckenbaldachin mit kleinen Abmessungen und unsichtbaren Schrauben.

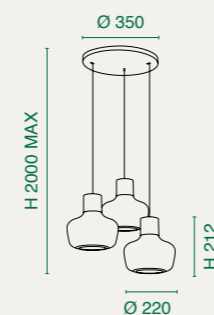

LED Warm white 3000K - 36W - 3900 lm

3767-47-102 Bianco - White

3767-47-365 Cognac

Dimmerabile a step
 Steps dimmable
 Gradable
 In Stufen dimmbar

CE IP20



kino 3767

Blanc - Weiß Cognac

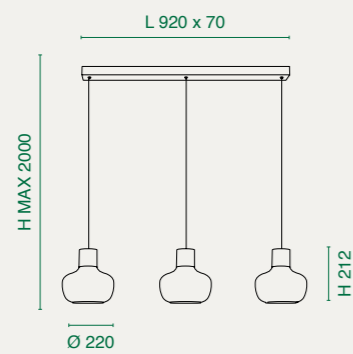

LED Warm white 3000K - 36W - 3900 lm

3767-48-102 Bianco - White

3767-48-365 Cognac

Dimmerabile a step
Steps dimmable
Gradable
In Stufen dimmbar

CE IP20

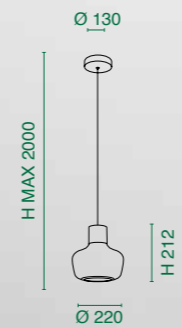

LED Warm white 3000K - 12W - 1300 lm

3767-40-102 Bianco - White

3767-40-365 Cognac

Dimmerabile a step
Steps dimmable
Gradable
In Stufen dimmbar

CE IP20



Struttura in metallo e vetro borosilicato - Metal frame and borosilicate glass
 Monture en métal et verre borosilicaté - Metall und Borsilicatglas



suspension

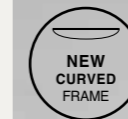

Per queste sospensioni è stato realizzato un nuovo rosone dalle dimensioni contenute e con viti invisibili.
 These suspensions have a new canopy of small dimensions and invisible screws.
 Ces suspensions ont une nouvelle plafond de petites dimensions et avec vis invisibles.
 Diese Aufhängungen haben eine neue Deckenbaldachin mit kleinen Abmessungen und unsichtbaren Schrauben.



lapo 3768

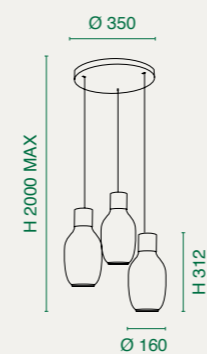

LED Warm white 3000K - 36W - 3900 lm

3768-47-365 Cognac

Dimmerabile a step
 Steps dimmable
 Gradable
 In Stufen dimmbar

CE IP20



Cognac

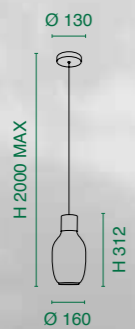

LED Warm white 3000K - 12W - 1300 lm

3768-40-365 Cognac

Dimmerabile a step
Steps dimmable
Gradable
In Stufen dimmbar

CE IP20

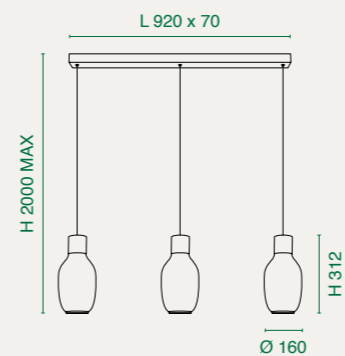

LED Warm white 3000K - 36W - 3900 lm

3768-48-365 Cognac

Dimmerabile a step
Steps dimmable
Gradable
In Stufen dimmbar

CE IP20



arabella



Design s.t. Fabas Luce

3547



Struttura in metallo e vetro borosilicato - Metal frame and borosilicate glass
 Monture en métal et verre borosilicaté - Metall und Borsilicatglas





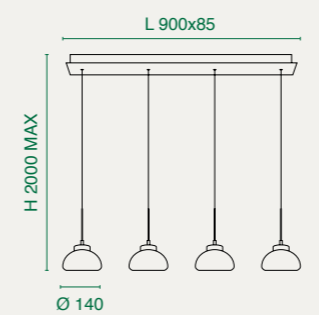



suspension

Ambre - Amber   Blanc - Weiss
 Gris transparent - Grau transparent 



LED Warm white 3000K - 32W - 3020 lm
3547-48-102  Bianco - White
3547-48-125  Ambra - Amber
3547-48-126  Fumé - Transparent grey

Dimmerabile a step
 Steps dimmable
 Gradable
 In Stufen dimmbar
 Integrato - Integrated - Intégré - Integriert
 [Pagina - Page - Seite 467]
  IP20 

Ambre - Amber  Blanc - Weiss 
 Gris transparent - Grau transparent 

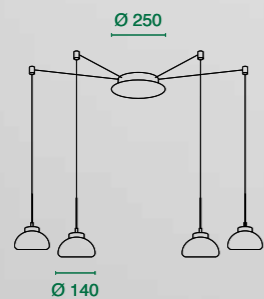





LED Warm white 3000K - 32W - 3020 lm

3547-49-102  Bianco - White



3547-49-125  Ambra - Amber

3547-49-126  Fumé - Transparent grey

-  LED dimmerabile a taglio di fase
-  Phase cut dimmable LED
-  LED dimmable à découpage de phase
-  LED dimmbar (über Phasen- und abschnitt-dimmer)

 Integrato - Integrated - Intégré - Integriert
 [Pagina - Page - Seite 467]

Lunghezza di ogni cavo 3500 mm
 Length of each cable 3500 mm
 Longueur de chaque cable 3500 mm
 Kabellänge je 3500 mm

CE   IP20 

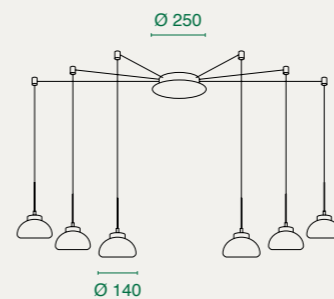





LED Warm white 3000K - 48W - 4530 lm

3547-46-102  Bianco - White



3547-46-125  Ambra - Amber



3547-46-126  Fumé - Transparent grey

-  LED dimmerabile a taglio di fase
-  Phase cut dimmable LED
-  LED dimmable à découpage de phase
-  LED dimmbar (über Phasen- und abschnitt-dimmer)

 Integrato - Integrated - Intégré - Integriert
 [Pagina - Page - Seite 467]

Lunghezza di ogni cavo 3500 mm
 Length of each cable 3500 mm
 Longueur de chaque cable 3500 mm
 Kabellänge je 3500 mm

CE   IP20 

Ambre - Amber   Blanc - Weiss
 Gris transparent - Grau transparent 





suspension

arabella 3547





LED Warm white 3000K - 8W - 750 lm



3547-40-102  Bianco - White

3547-40-125  Ambra - Amber

3547-40-126  Fumé - Transparent grey

 LED dimmerabile a taglio di fase
 Phase cut dimmable LED
 LED dimmable à découpage de phase
 LED dimmbar (über Phasen- und abschnittdimmer)

 Integrato - Integrated - Intégré - Integriert
 [Pagina - Page - Seite 467]

CE   IP20 

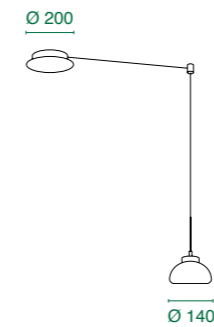



LED Warm white 3000K - 8W - 750 lm

3547-41-102  Bianco - White



3547-41-125  Ambra - Amber

3547-41-126  Fumé - Transparent grey

 LED dimmerabile a taglio di fase
 Phase cut dimmable LED
 LED dimmable à découpage de phase
 LED dimmbar (über Phasen- und abschnittdimmer)

 Integrato - Integrated - Intégré - Integriert
 [Pagina - Page - Seite 467]

Lunghezza cavo 3500 mm
 Length cable 3500 mm
 Longueur cable 3500 mm
 Kabellänge 3500 mm

CE   IP20 

3410

Struttura in metallo e metacrilato - Metal and methacrylate frame
 Monture en métal et méthacrylate - Metall - und Methacrylatgestell

suspension



LED Warm white 3000K - 8W - 750 lm

3410-41-212  Alluminio satinato
 Satined aluminum

 LED dimmerabile a taglio di fase
 Phase cut dimmable LED
 LED dimmable à découpage de phase
 LED dimmbar (über Phasen- und abschnittdimmer)

 Integrato - Integrated - Intégré - Integriert
 [Pagina - Page - Seite 467]

Lunghezza cavo 3500 mm
 Length cable 3500 mm
 Longueur cable 3500 mm
 Kabellänge 3500 mm

CE   IP20



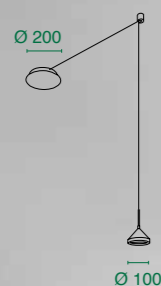



 Aluminium satiné - Aluminium satiniert





LED Warm white 3000K - 32W - 3020 lm

3410-49-212  Alluminio satinato
 Satined aluminum

 LED dimmerabile a taglio di fase
 Phase cut dimmable LED
 LED dimmable à découpage de phase
 LED dimmbar (über Phasen- und abschnittdimmer)

 Integrato - Integrated - Intégré - Integriert
 [Pagina - Page - Seite 467]

Lunghezza di ogni cavo 3500 mm
 Length of each cable 3500 mm
 Longueur de chaque cable 3500 mm
 Kabellänge je 3500 mm

CE   IP20





LED Warm white 3000K - 48W - 4530 lm

3410-46-212  Alluminio satinato
 Satined aluminum

 LED dimmerabile a taglio di fase
 Phase cut dimmable LED
 LED dimmable à découpage de phase
 LED dimmbar (über Phasen- und abschnittdimmer)

 Integrato - Integrated - Intégré - Integriert
 [Pagina - Page - Seite 467]

Lunghezza di ogni cavo 3500 mm
 Length of each cable 3500 mm
 Longueur de chaque cable 3500 mm
 Kabellänge je 3500 mm

CE   IP20



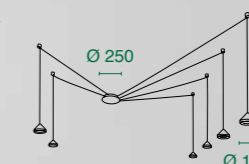





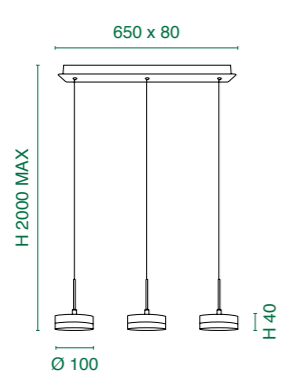



suspension





LED Warm white 3000K - 24W - 2260 lm
3239-47-119  Ottone satinato / Satined brass
3239-47-212  Alluminio spazzolato / Brushed aluminum

LED dimmerabile a taglio di fase
 Phase cut dimmable LED
 LED dimmable à découpage de phase
 LED dimmbar (über Phasen an- und abschnittdimmer)

 Compatibile - Compatible - Kompatibel
 [Pagina - Page - Seite 467]

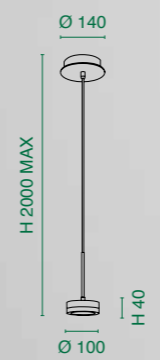

CE   IP20  E



LED Warm white 3000K - 8W - 750 lm
3239-40-119  Ottone satinato / Satined brass
3239-40-212  Alluminio spazzolato / Brushed aluminum

LED dimmerabile a taglio di fase
 Phase cut dimmable LED
 LED dimmable à découpage de phase
 LED dimmbar (über Phasen an- und abschnittdimmer)

 Compatibile - Compatible - Kompatibel
 [Pagina - Page - Seite 467]

CE   IP20  E

dunk 3239

Laiton satiné - Messing satiniert   Aluminium brossé - Aluminium gebürstet

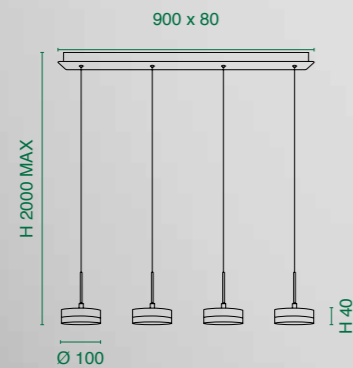





LED Warm white 3000K - 32W - 3020 lm

3239-49-119  Ottone satinato
Satinéd brass

3239-49-212  Alluminio spazzolato
Brushed aluminum

 LED dimmerabile a taglio di fase
Phase cut dimmable LED
LED dimmable à découpage de phase
LED dimmbar (über Phasen-an- und abschnittdimmer)

 Compatibile - Compatible - Kompatibel
[Pagina - Page - Seite 467]

CE   IP20  E

suspension

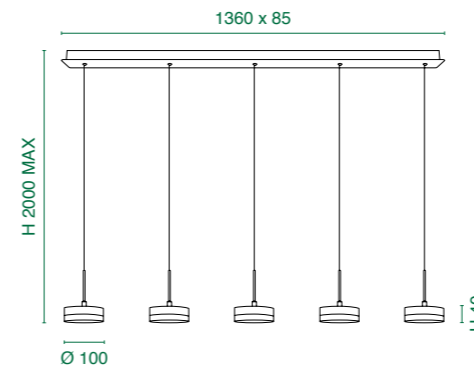

LED Warm white 3000K - 40W - 3780 lm

3239-48-119  Ottone satinato
Satinéd brass

3239-48-212  Alluminio spazzolato
Brushed aluminum

 LED dimmerabile a taglio di fase
Phase cut dimmable LED
LED dimmable à découpage de phase
LED dimmbar (über Phasen-an- und abschnittdimmer)

 Compatibile - Compatible - Kompatibel
[Pagina - Page - Seite 467]

CE   IP20  E

dunk 3239

suspension



Doppia emissione parte superiore e inferiore.
Bi-emission light up & down.
Lumière à bi-émission haut et bas.
Zweiseitiger Lichtaustritt up & down.

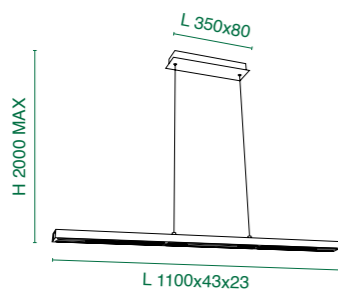

LED Warm white 3000K - 40W - 4800 lm

3712-45-101 ■ Nero - Black

3712-45-119 ■ Ottone satinato - Satined brass

Regolazione luce con pulsante
Push dimmer
Bouton poussoir dimmable
Tastdimmer

CE IP20



ling 3712

3681

Struttura in metallo e policarbonato - Metal and polycarbonate frame
 Structure en métal et polycarbonate - Metall- und Polycarbonatstruktur



suspension

Doppia emissione parte superiore e inferiore.
 Bi-emission light up & down.
 Lumière à bi-émission haut et bas.
 Zweiseitiger Lichtaustritt up & down.

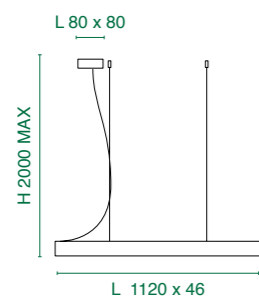

LED Warm white 3000K - 22+23W - 2600+2860 lm

3681-40-101 ■ Nero - Black

3681-40-102 □ Bianco - White

Regolazione luce con pulsante
 Push dimmer
 Bouton poussoir dimmable
 Tastdimmer

CE IP20



Noir - Schwarz ■ □ Blanc - Weiss



Doppia emissione parte superiore e inferiore.
 Bi-emission light up & down.
 Lumière à bi-émission haut et bas.
 Zweiseitiger Lichtaustritt up & down.s

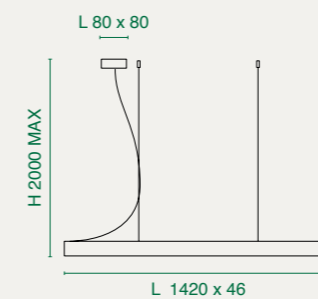

LED Warm white 3000K - 28+30W - 3380+3640 lm

3681-45-101 ■ Nero - Black

3681-45-102 □ Bianco - White

Regolazione luce con pulsante
 Push dimmer
 Bouton poussoir dimmable
 Tastdimmer

CE IP20



Struttura in metallo e metacrilato - Metal and methacrylate frame
Monture en métal et méthacrylate - Metall- und Methacrylatgestell



suspension

Noir - Schwarz Blanc - Weiss



giotto 3508

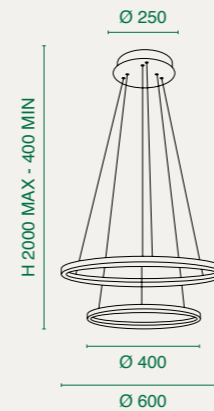

LED Warm white 3000K - 52W - 5320 lm

3508-45-101 Nero - Black

3508-45-102 Bianco - White

LED dimmerabile a taglio di fase
Phase cut dimmable LED
LED dimmable à découpage de phase
LED dimmbar (über Phasen- und abschnittdimmer)

Integrato - Integrated - Intégré - Integriert
[Pagina - Page - Seite 467]

CE IP40

- Noir - Schwarz
- Blanc - Weiss

3508-45

Anello esterno e interno con luce verso il basso.
 Outer and inner ring with light downwards.
 Anneau extérieur et intérieur avec lumière vers le bas.
 Äußerer und innerer Ring mit nach unten gerichtetem Licht.

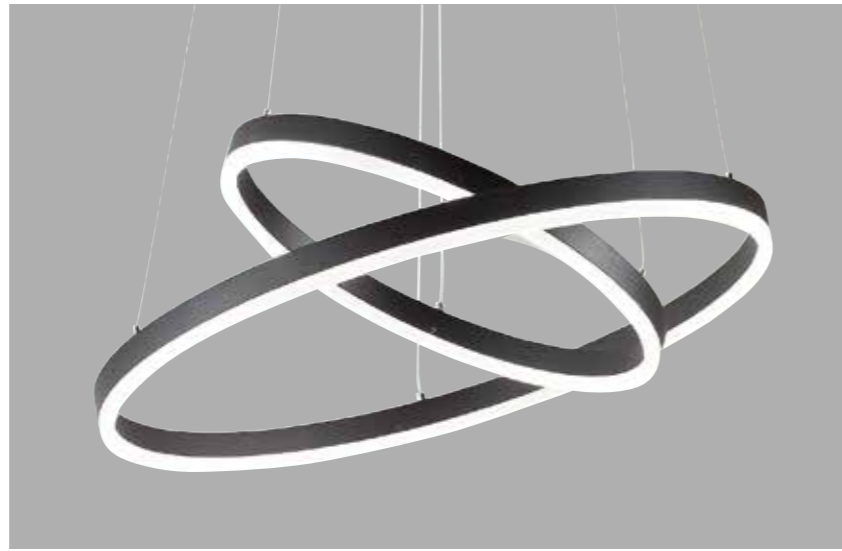

3508-48

Anello esterno con luce verso il basso, anello interno con luce verso l'alto.
 Outer ring with downward light, inner ring with upward light.
 Anneau extérieur avec lumière vers le bas, anneau intérieur avec lumière vers le haut.
 Äußerer Ring mit nach unten gerichtetem Licht, innerer Ring mit nach oben gerichtetem Licht.



suspension

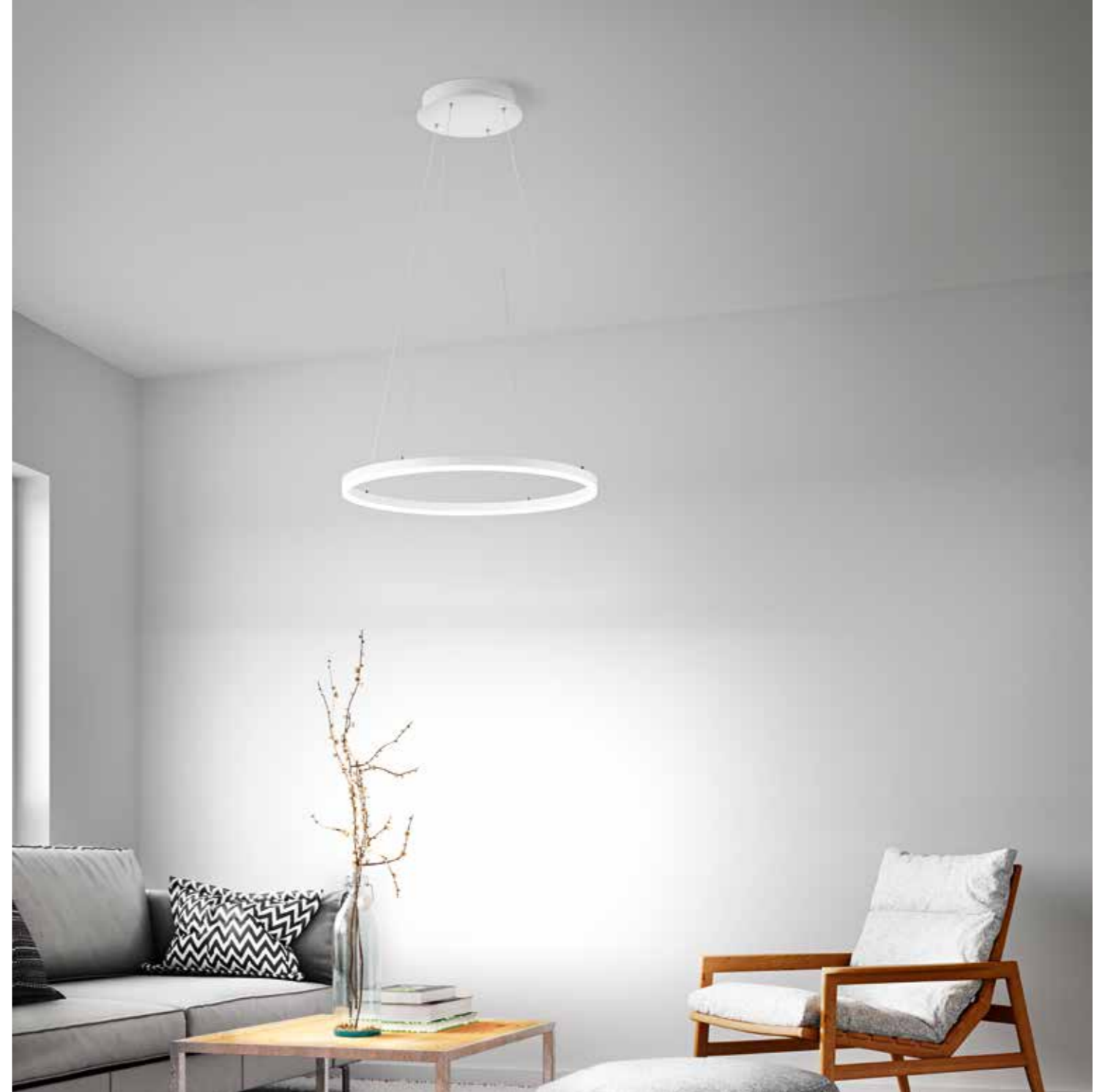

giotto 3508

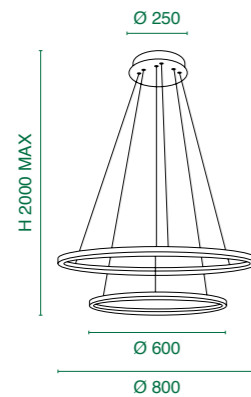

LED Warm white 3000K - 65W - 7050 lm

3508-48-101 Nero - Black

3508-48-102 Bianco - White

- LED dimmerabile a taglio di fase
- Phase cut dimmable LED
- LED dimmable à découpage de phase
- LED dimmbar (über Phasen- und abschnittdimmer)

Integrato - Integrated - Intégré - Integriert
 [Pagina - Page - Seite 467]

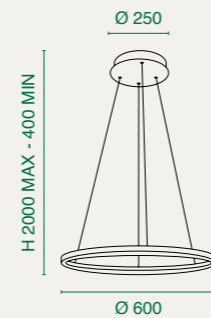

LED Warm white 3000K - 36W - 3780 lm

3508-40-101 Nero - Black

3508-40-102 Bianco - White

- LED dimmerabile a taglio di fase
- Phase cut dimmable LED
- LED dimmable à découpage de phase
- LED dimmbar (über Phasen- und abschnittdimmer)

Integrato - Integrated - Intégré - Integriert
 [Pagina - Page - Seite 467]

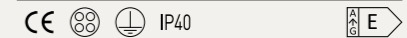

Noir - Schwarz  Blanc - Weiss 





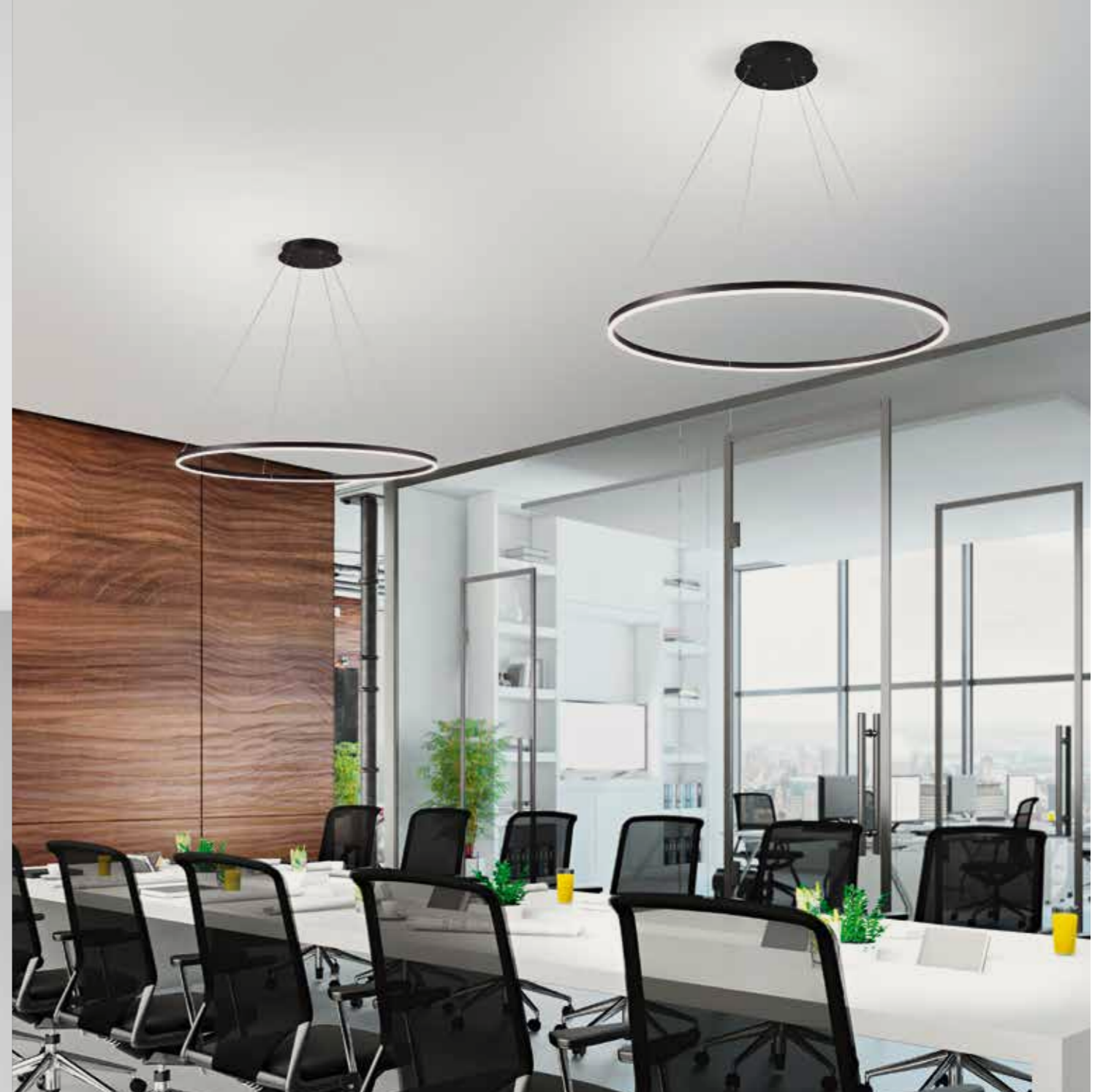

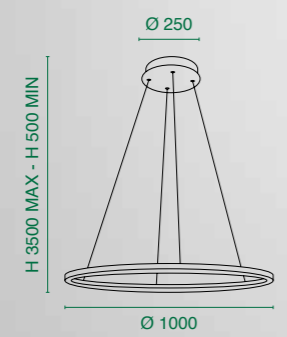

suspension







giotto 3508

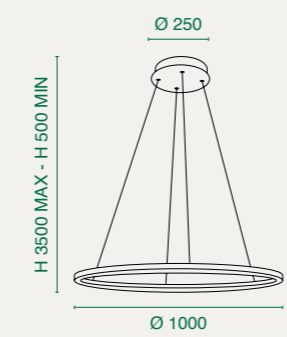

LED Natural white 4000K - 60W - 6700 lm
3508-42-101  Nero - Black
3508-42-102  Bianco - White
 LED dimmerabile a taglio di fase
 Phase cut dimmable LED
 LED dimmable à découpage de phase
 LED dimmbar (über Phasen-an- und abschnitt-dimmer)
 Integrato - Integrated - Intégré - Integriert
 [Pagina - Page - Seite 467]
 CE   IP20 



LED Warm white 3000K - 60W - 6300 lm
3508-46-101  Nero - Black
3508-46-102  Bianco - White
 LED dimmerabile a taglio di fase
 Phase cut dimmable LED
 LED dimmable à découpage de phase
 LED dimmbar (über Phasen-an- und abschnitt-dimmer)
 Integrato - Integrated - Intégré - Integriert
 [Pagina - Page - Seite 467]
 CE   IP20 

3394

Struttura in metallo e metacrilato - Metal and methacrylate frame
 Monture en métal et méthacrylate - Metall und Methacrylat

collection: page 216 page 268 page 376

Noir - Schwarz Blanc - Weiss
 Or mat - Gold edelmatt Anthracite - Anthrazit
 Corten - Rostbraun

suspension



bard 3394

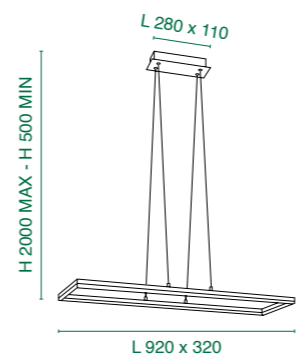

LED Natural white 4000K - 52W - 5400 lm
3394-43-102 Bianco - White
3394-43-282 Antracite - Anthracite

LED dimmerabile a taglio di fase
 Phase cut dimmable LED
 LED dimmable à découpage de phase
 LED dimmbar (über Phasen- und abschnittsdimmer)

CE IP40

LED Warm white 3000K - 52W - 5180 lm
3394-45-101 Nero - Black
3394-45-102 Bianco - White
3394-45-225 Oro opaco - Gold matt
3394-45-282 Antracite - Anthracite
3394-45-361 Corten - Rostbraun

LED dimmerabile a taglio di fase
 Phase cut dimmable LED
 LED dimmable à découpage de phase
 LED dimmbar (über Phasen- und abschnittsdimmer)

CE IP40



Noir - Schwarz Or mat - Gold edelmatt
 Anthracite - Anthrazit

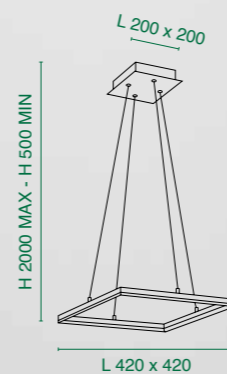

LED Warm white 3000K - 39W - 3880 lm

3394-40-102 Bianco - White

3394-40-225 Oro opaco - Gold matt

3394-40-282 Antracite - Anthracite

LED dimmerabile a taglio di fase
 Phase cut dimmable LED
 LED dimmable à découpage de phase
 LED dimmbar (über Phasen- und abschnittdimmer)

Integrato - Integrated - Intégré - Integriert
 [Pagina - Page - Seite 467]

CE IP40

palau

Design s.t. Fabas Luce

3743

Struttura in metallo e metacrilato - Metal and methacrylate frame
 Monture en métal et méthacrylate - Metall und Methacrylat



suspension

Blanc - Weiss Or mat - Gold edelmatt

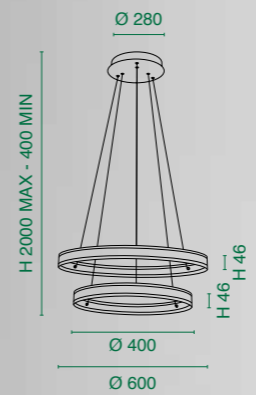

LED Warm white 3000K - 108W - 11780 lm

3743-45-102 Bianco - White

3743-45-225 Oro opaco - Gold matt

LED dimmerabile a taglio di fase
 Phase cut dimmable LED
 LED dimmable à découpage de phase
 LED dimmbar (über Phasen- und abschnitt-dimmer)

CE IP20



Blanc - Weiss Or mat - Gold edelmatt

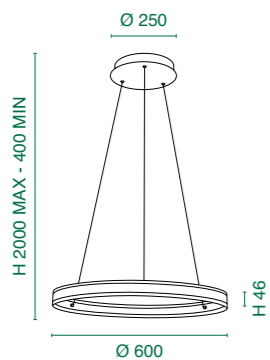

LED Warm white 3000K - 60W - 6540 lm

3743-40-102 Bianco - White

3743-40-225 Oro opaco - Gold matt

LED dimmerabile a taglio di fase
Phase cut dimmable LED
LED dimmable à découpage de phase
LED dimmbar (über Phasen-an- und abschnitt-dimmer)

Compatibile - compatible - Kompatibel
[Pagina - Page - Seite 467]

CE IP20

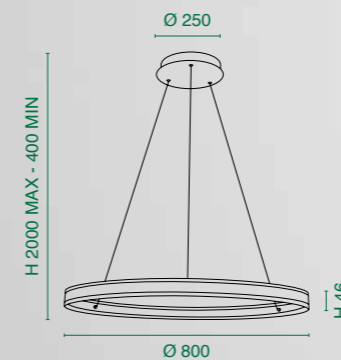

LED Warm white 3000K - 64W - 6980 lm

3743-46-102 Bianco - White

3743-46-225 Oro opaco - Gold matt

LED dimmerabile a taglio di fase
Phase cut dimmable LED
LED dimmable à découpage de phase
LED dimmbar (über Phasen-an- und abschnitt-dimmer)

Compatibile - compatible - Kompatibel
[Pagina - Page - Seite 467]

CE IP20

sylvie

Design Variaforma

3626

Struttura in metallo e metacrilato - Metal and methacrylate frame
 Monture en métal et méthacrylate - Metall- und Methacrylatgestell



suspension

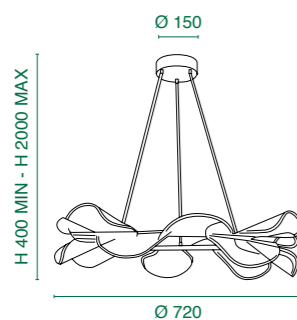

LED Warm white 3000K - 40W - 5500 lm

3626-45-102 Bianco - White

LED dimmerabile a taglio di fase
 Phase cut dimmable LED
 LED dimmable à découpage de phase
 LED dimmbar (über Phasen- und abschnittdimmer)

Integrato - Integrated - Intégré - Integriert
 [Pagina - Page - Seite 467]

CE IP20

Blanc - Weiss



sylvie 3626



LED Warm white 3000K - 30W - 4000 lm

3626-46-102 Bianco - White

LED dimmerabile a taglio di fase
 Phase cut dimmable LED
 LED dimmable à découpage de phase
 LED dimmbar (über Phasen- und abschnittdimmer)

Integrato - Integrated - Intégré - Integriert
 [Pagina - Page - Seite 467]

CE IP20

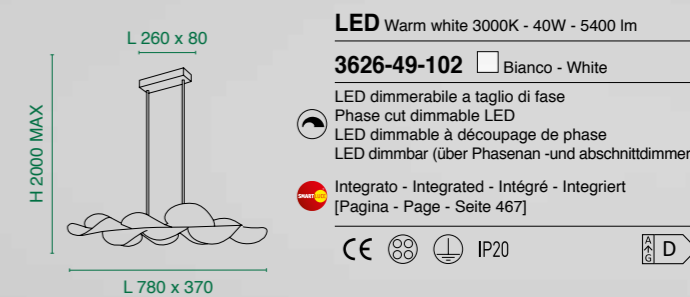

LED Warm white 3000K - 40W - 5400 lm

3626-49-102 Bianco - White

LED dimmerabile a taglio di fase
 Phase cut dimmable LED
 LED dimmable à découpage de phase
 LED dimmbar (über Phasen- und abschnittdimmer)

Integrato - Integrated - Intégré - Integriert
 [Pagina - Page - Seite 467]

CE IP20

3625

Struttura in metallo e metacrilato - Metal and methacrylate frame
 Monture en métal et méthacrylate - Metall- und Methacrylatgestell

collection: **page 230**



page 374

page 430

Blanc - Weiss

suspension

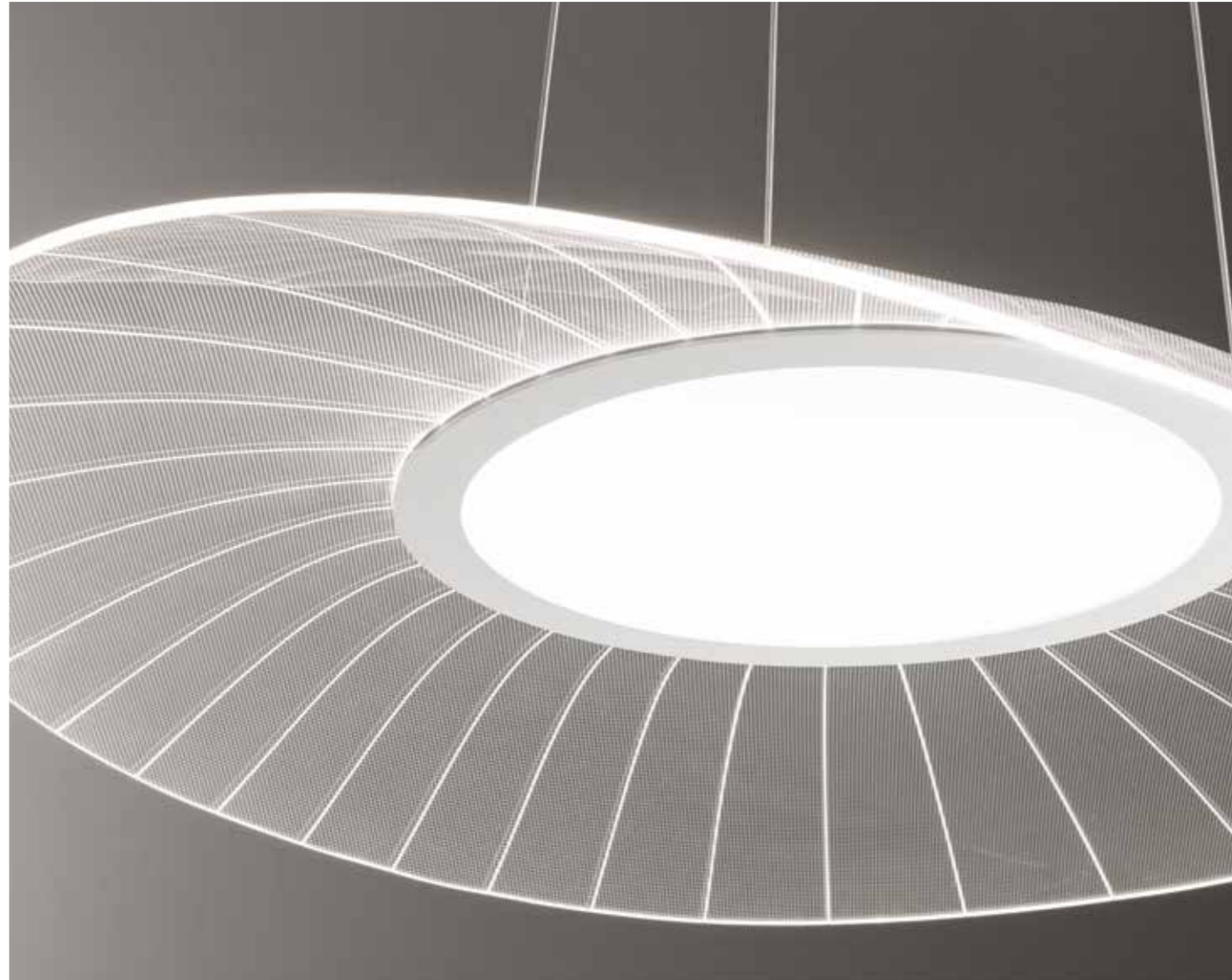

vela 3625

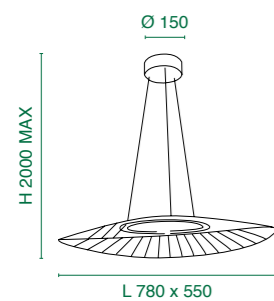

LED Warm white 3000K - 40W - 5400 lm

3625-45-102 Bianco - White

- LED dimmerabile a taglio di fase
- Phase cut dimmable LED
- LED dimmable à découpage de phase
- LED dimmbar (über Phasen- und abschnittdimmer)

Integrato - Integrated - Intégré - Integriert
 [Pagina - Page - Seite 467]

CE IP20

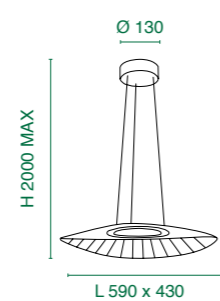

LED Warm white 3000K - 24W - 3400 lm

3625-40-102 Bianco - White

- LED dimmerabile a taglio di fase
- Phase cut dimmable LED
- LED dimmable à découpage de phase
- LED dimmbar (über Phasen- und abschnittdimmer)

Integrato - Integrated - Intégré - Integriert
 [Pagina - Page - Seite 467]

CE IP20

3666

Struttura in metallo e metacrilato - Metal and methacrylate frame
 Monture en métal et méthacrylate - Metall - und Methacrylatgestell

suspension



Noir - Schwarz Blanc - Weiss



sinuo 3666

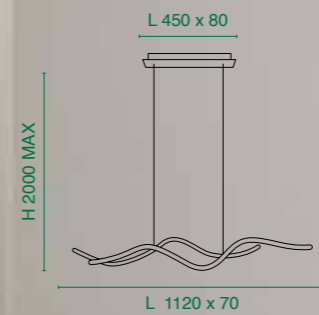

LED Warm white 3000K - 36W - 3880 lm

3666-45-101 Nero - Black

3666-45-102 Bianco - White

Dimmerabile a step
 Steps dimmable
 Gradable
 In Stufen dimmbar

CE

E

3481

Struttura in metallo e vetro borosilicato - Metal frame and borosilicate glass
 Monture en métal et verre borosilicaté - Metall und Borsilicatglas

collection: **page 208**



suspension



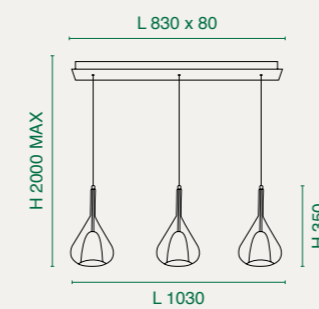

Ambre - Amber  Gris transparent - Grau transparent 
 Transparent 

lila 3481









E27 3x40W

3481-48-297   

Ambra - Amber
 Fumé - Transparent grey
 Trasparente - Transparent

 Compatibile - Compatible - Kompatibel
 [Pagina - Page - Seite 467]

   IP20

Ambre - Amber   Gris transparent - Grau transparent
 Transparent 







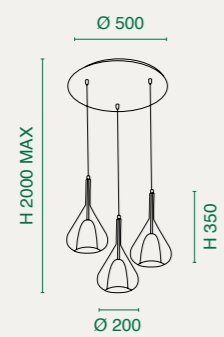

suspension



lila 3481



E27 3x40W
3481-47-297   
 Ambra - Amber
 Fumé - Transparent grey
 Trasparente - Transparent
 CE    IP20

- Ambre - Amber Gris transparent - Grau transparent
- Vert transparent - Transparent grün Transparent
- Bleu ciel - Azurblau



suspension

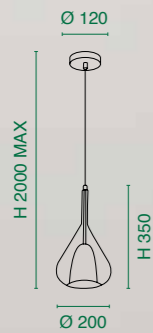

E27 1x40W

- 3481-40-125** Ambra - Amber
- 3481-40-126** Fumé - Transparent grey
- 3481-40-140** Verde trasparente - Transparent green
- 3481-40-241** Trasparente - Transparent
- 3481-40-244** Azzurro trasparente - Light blue

CE IP20

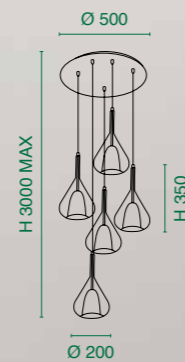

E27 5x40W

- 3481-49-362**
- Ambra - Amber
- Fumé - Transparent grey
- Verde trasparente - Transparent green
- Trasparente - Transparent
- Azzurro trasparente - Light blue

CE IP20

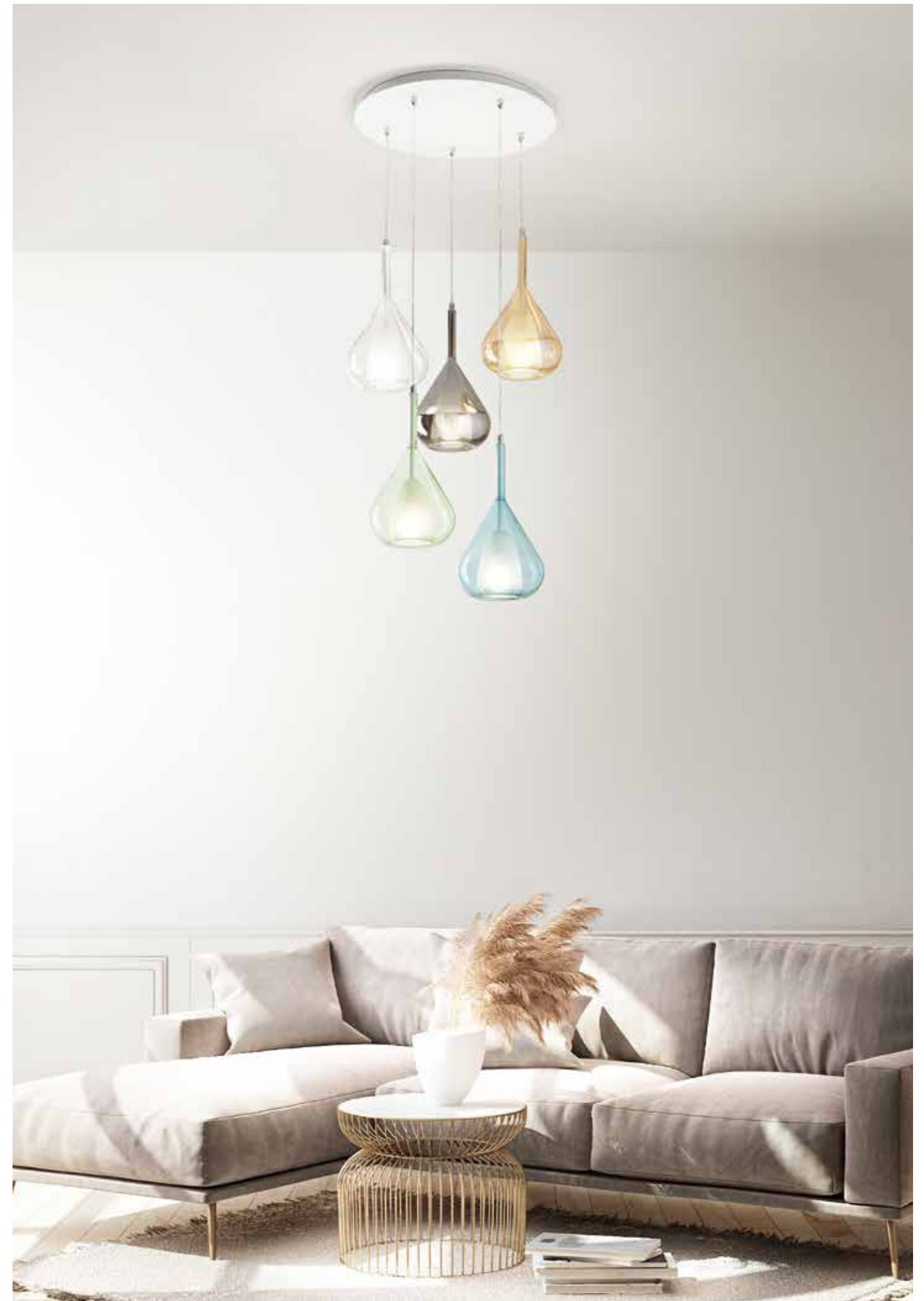

lila 3481

3519

Struttura in metallo e vetro soffiato - Metal frame and blown glass
 Monture en métal et verre soufflé - Metallgestell und geblasenes Glas

collection:



page
368



suspension

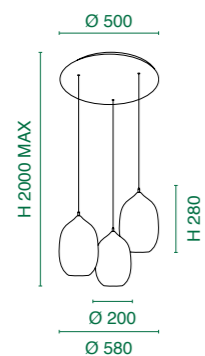

E27 3x60W

3519-47-126 ■ Fumé - Transparent grey

Integrato - Integrated - Intégré - Integriert
 [Pagina - Page - Seite 467]

CE IP20

■ Gris transparent - Grau transparent

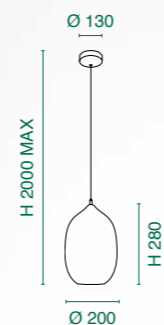

E27 1x60W

3519-40-126 ■ Fumé - Transparent grey

Integrato - Integrated - Intégré - Integriert
 [Pagina - Page - Seite 467]

CE IP20

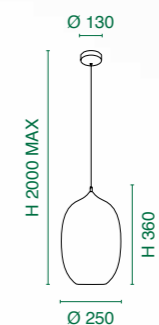

E27 1x60W

3519-45-126 ■ Fumé - Transparent grey

Integrato - Integrated - Intégré - Integriert
 [Pagina - Page - Seite 467]

CE IP20

infinity 3519

fiona

Design s.t. Fabas Luce

3496

Struttura in metallo e vetro soffiato - Metal frame and blown glass
Monture en métal et verre soufflé - Metallgestell und geblasenes Glas



suspension



Ambre - Amber  Gris transparent - Grau transparent 



fiona 3496

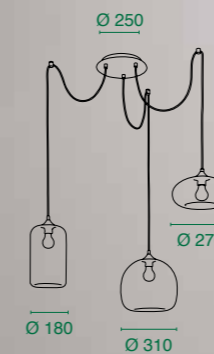



E27 3x60W

3496-47-125  Ambra - Amber

3496-47-126  Fumé - Transparent grey

Lunghezza di ogni cavo 3000 mm
Length of each cable 3000 mm
Longueur de chaque cable 3000 mm
Kabellänge je 3000 mm

CE   IP20

3490

Struttura in metallo e vetro soffiato - Metal frame and blown glass
Monture en métal et verre soufflé - Metallgestell und geblasenes Glas



suspension





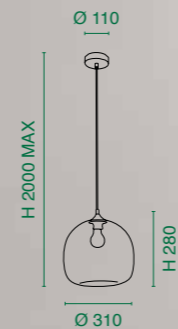

Ambre - Amber  Gris transparent - Grau transparent 



E27 1x60W

3490-40-125  Ambra - Amber

3490-40-126  Fumé - Transparent grey

CE    IP20

3489

Struttura in metallo e vetro soffiato - Metal frame and blown glass
 Monture en métal et verre soufflé - Metallgestell und geblasenes Glas



suspension

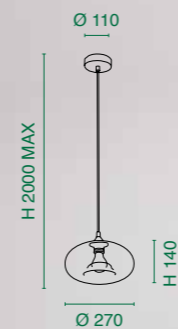

Ambre - Amber  Gris transparent - Grau transparent 



E27 1x60W

3489-40-125  Ambra - Amber

3489-40-126  Fumé - Transparent grey

CE    IP20

3491

Struttura in metallo e vetro soffiato - Metal frame and blown glass
 Monture en métal et verre soufflé - Metallgestell und geblasenes Glas



Ambre - Amber Gris transparent - Grau transparent



silo 3491

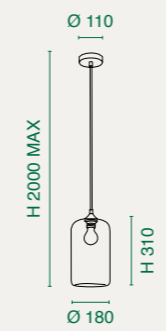

E27 1x60W

3491-40-125 Ambra - Amber

3491-40-126 Fumé - Transparent grey

CE IP20

3480

Struttura in metallo e vetro soffiato - Metal frame and blown glass
 Monture en métal et verre soufflé - Metall und geblasenes Glas



suspension

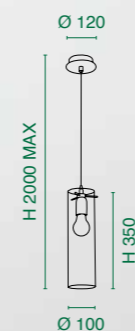
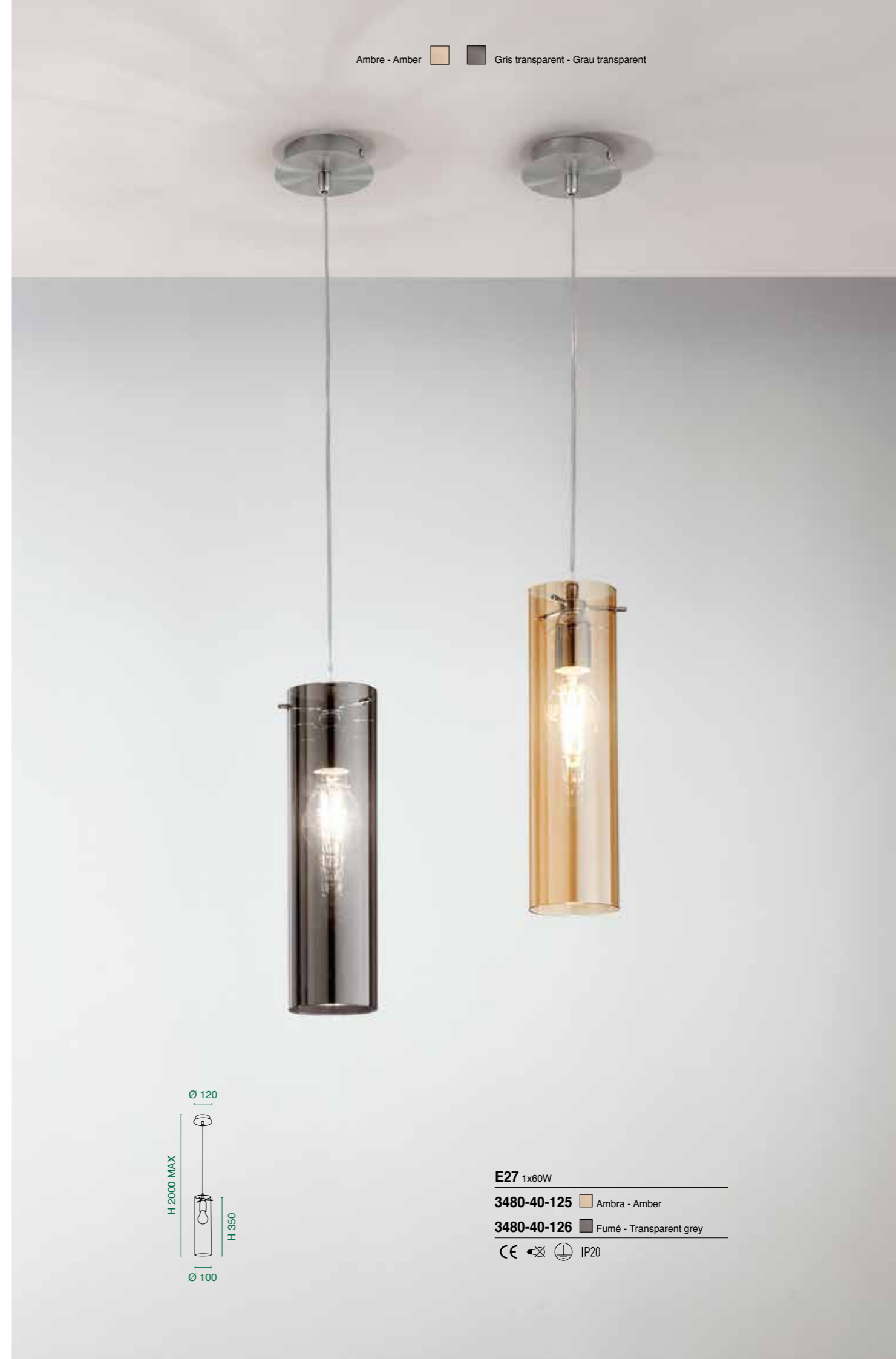

Ambre - Amber  Gris transparent - Grau transparent 



E27 1x60W

3480-40-125  Ambra - Amber

3480-40-126  Fumé - Transparent grey

CE    IP20



Ambre - Amber Gris transparent - Grau transparent

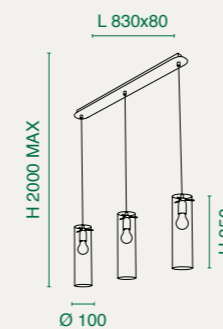

E27 3x60W

3480-47-125 Ambra - Amber

3480-47-126 Fumé - Transparent grey

Compatible - Compatible - Kompatibel
[Pagina - Page - Seite 467]

IP20

Struttura in metallo e vetro soffiato - Metal frame and blown glass
 Monture en métal et verre soufflé - Metall und geblasenes Glas





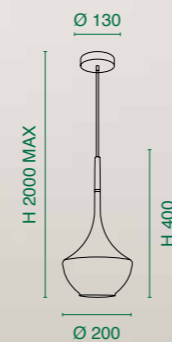

suspension

Noir - Schwarz Blanc - Weiss
 Laiton satiné - Messing satiniert



- E27** 1x40W
- 3623-41-101** Nero - Black
- 3623-41-102** Bianco - White
- 3623-41-119** Ottone satinato - Satined brass

 Compatibile - Compatible - Kompatibel
 [Pagina - Page - Seite 467]

CE    IP20

3596

Struttura in metallo e vetro soffiato - Metal frame and blown glass
 Monture en métal et verre soufflé - Metall und geblasenes Glas



suspension



E27 1x40W

3596-40-125 Ambra - Amber

3596-40-126 Fumé - Transparent grey

Compatibile - Compatible - Kompatibel
 [Pagina - Page - Seite 467]

IP20

Ambre - Amber Gris transparent - Grau transparent

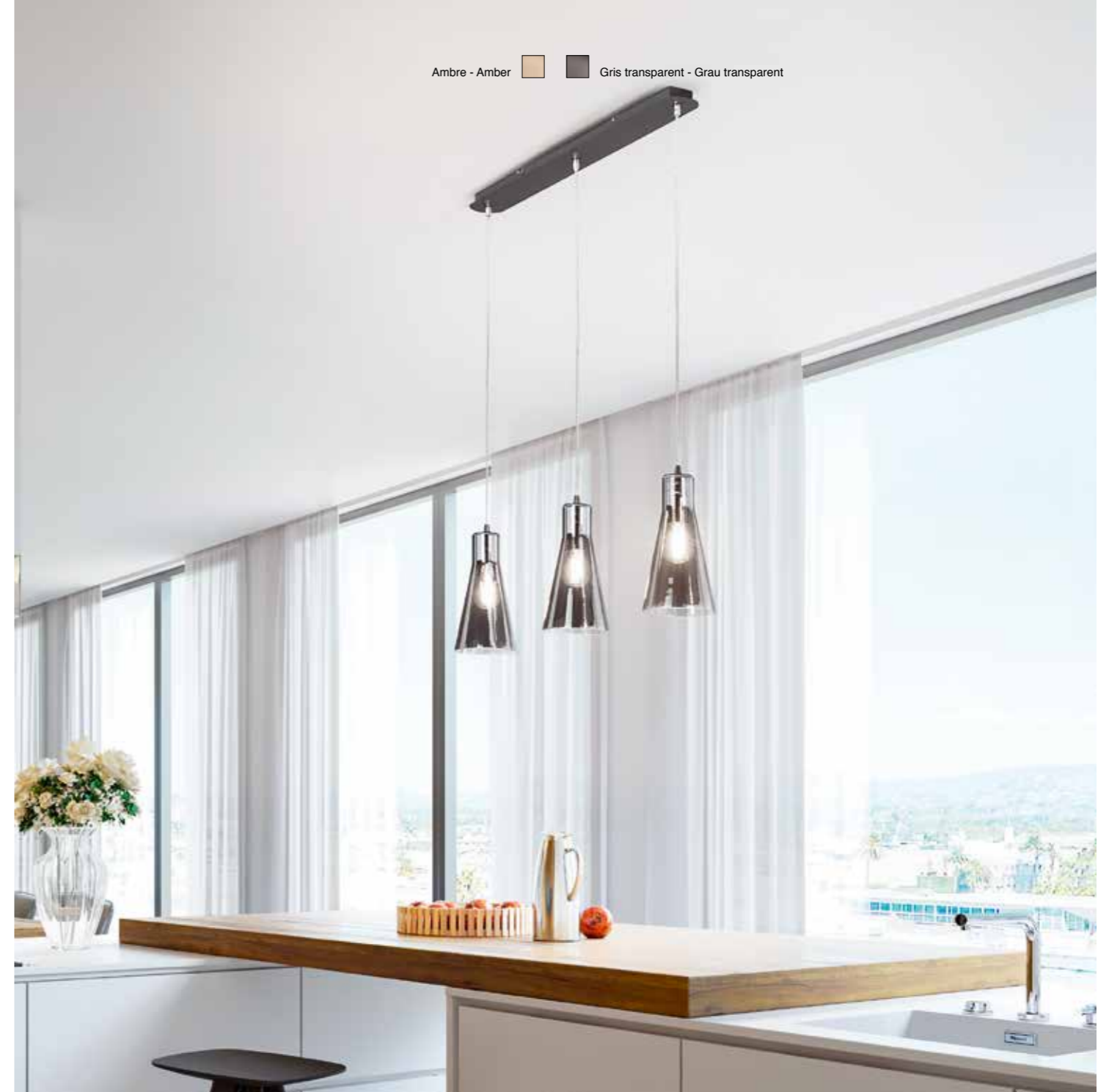

dafne 3596

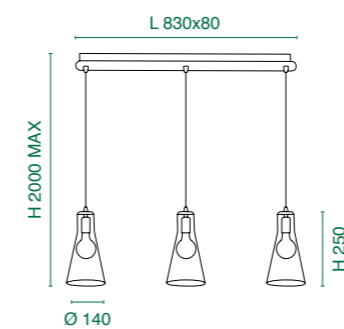

E27 3x40W

3596-47-125 Ambra - Amber

3596-47-126 Fumé - Transparent grey

Compatibile - Compatible - Kompatibel
 [Pagina - Page - Seite 467]

IP20



3673

Struttura in metallo e vetro borosilicato - Metal frame and borosilicate glass
 Monture en métal et verre borosilicaté - Metall und Borsilicatglas



suspension







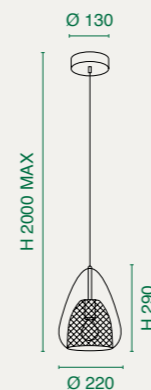

Ambre - Amber  Gris transparent - Grau transparent 
 Transparent 





britton 3673





- E27** 1x40W
- 3673-40-125**  Ambra - Amber
- 3673-40-126**  Fumé - Transparent grey
- 3673-40-241**  Trasparente - Transparent

   Compatibile - Compatible - Kompatibel
 [Pagina - Page - Seite 467]

   IP20



Ambre - Amber   Gris transparent - Grau transparent
Transparent 

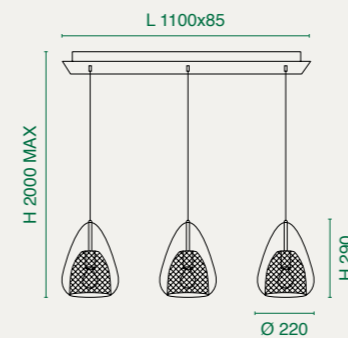



E27 3x40W

3673-48-125  Ambra - Amber

3673-48-126  Fumé - Transparent grey

3673-48-241  Trasparente - Transparent

 Compatible - Compatible - Kompatibel
[Pagina - Page - Seite 467]

CE   IP20

gisella

Design s.t. Fabas Luce

3518

collection:



page
367

Struttura in metallo e vetro soffiato - Metal frame and blown glass
Monture en métal et verre soufflé - Metallgestell und geblasenes glas



suspension

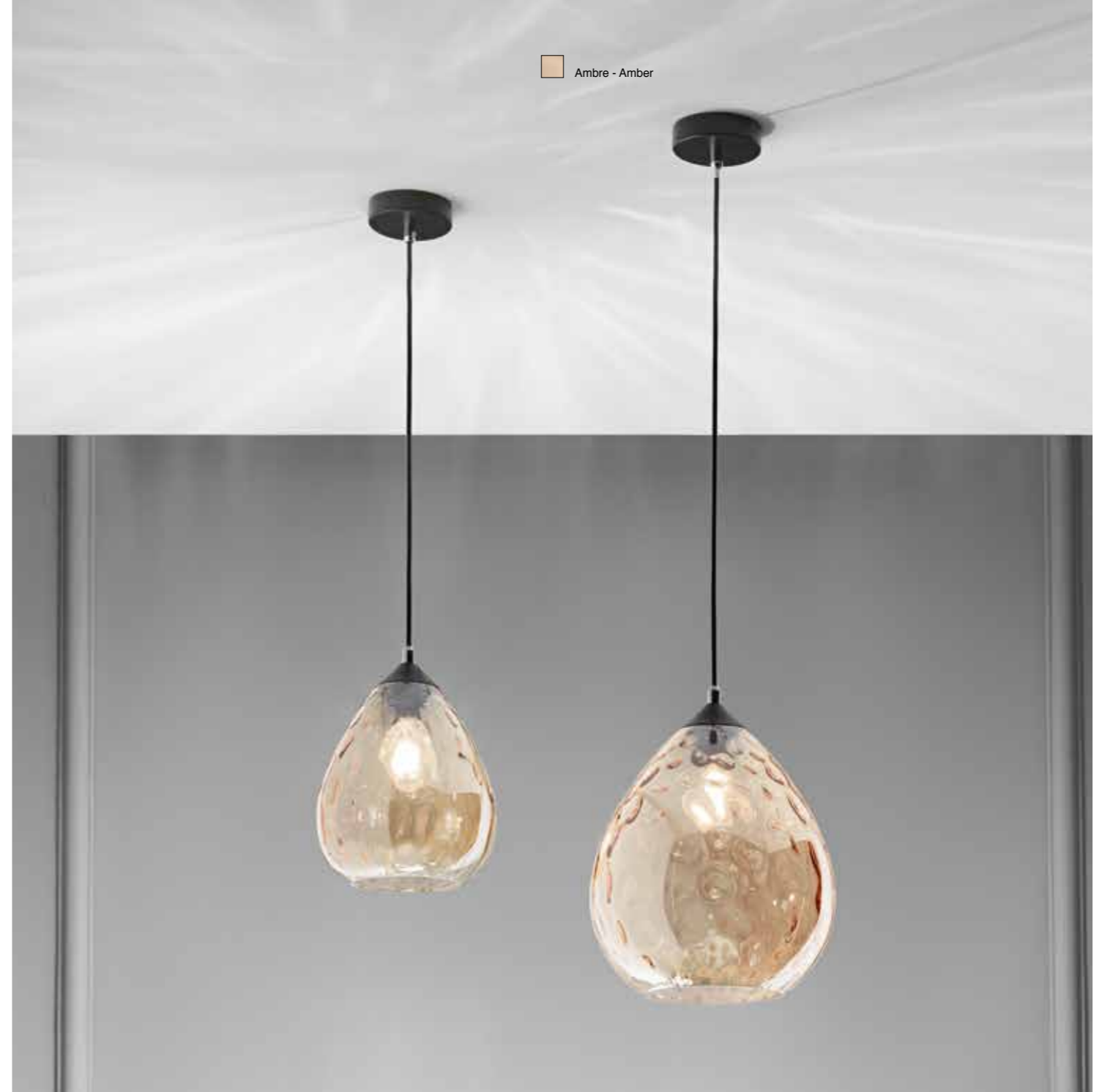

■ Ambra - Amber

gisella 3518

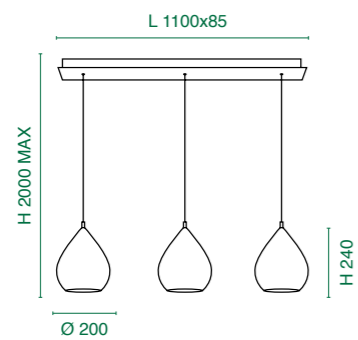

E27 3x60W

3518-49-125 ■ Ambra - Amber

Integrato - Integrated - Intégré - Integriert
[Pagina - Page - Seite 467]

CE IP20

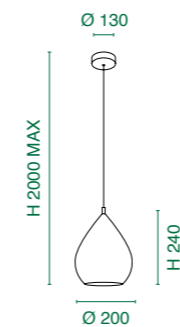

E27 1x60W

3518-40-125 ■ Ambra - Amber

Integrato - Integrated - Intégré - Integriert
[Pagina - Page - Seite 467]

CE IP20

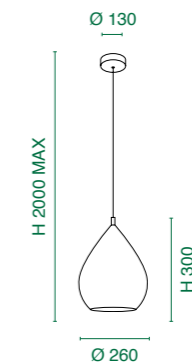

E27 1x60W

3518-45-125 ■ Ambra - Amber

Integrato - Integrated - Intégré - Integriert
[Pagina - Page - Seite 467]

CE IP20

gillis Design s.t. Fabas Luce
3627

Struttura in metallo e vetro soffiato - Metal frame and blown glass
Monture en métal et verre soufflé - Metall und geblasenes Glas

Ambre - Amber

Gris transparent - Grau transparent



suspension



gillis 3627

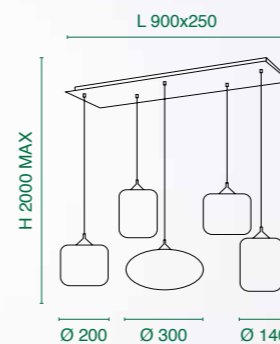

E27 5x40W

3627-48-125 Ambra - Amber

3627-48-126 Fumé - Transparent grey

Compatibile - Compatible - Kompatibel
[Pagina - Page - Seite 467]

CE IP20

3689

Struttura in metallo e vetro soffiato - Metal frame and blown glass
 Monture en métal et verre soufflé - Metall und geblasenes Glas

collection:

page
295

page
352

page
440

Noir - Schwarz



suspension



E27 1x40W

3689-40-101 ■ Nero - Black

Compatibile - Compatible - Kompatibel
 [Pagina - Page - Seite 467]

CE IP20



E27 1x40W

3689-45-101 ■ Nero - Black

Compatibile - Compatible - Kompatibel
 [Pagina - Page - Seite 467]

CE IP20



suspension

- Anthracite - Anthrazit
- Sable - Sandfarbe
- Brique - Ziegelfarbe

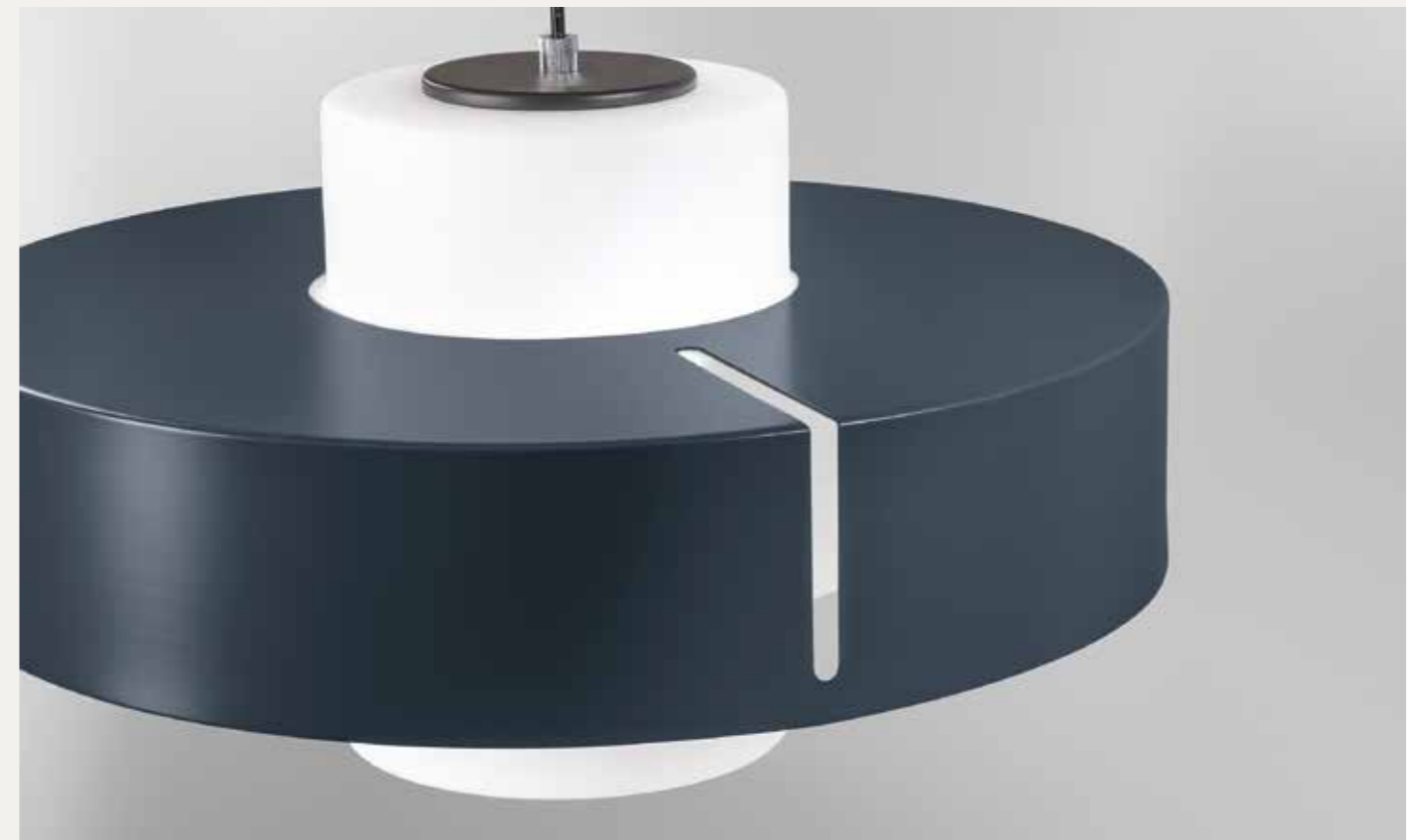

loto 3750

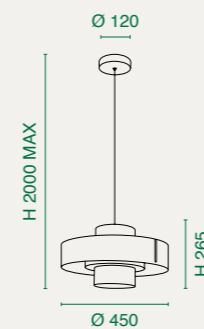

E27 1x40W

3750-40-282 Anthracite - Anthracite

3750-40-355 Sabbia - Sand

3750-40-358 Mattone - Bricky

CE IP20

aragon E27

Design s.t. Fabas Luce

3357

Struttura in metallo e vetro in lastra - Metal frame and plate glass
 Monture en metal et verre plat - Metallgestell und Glas

- Blanc - Weiss
- Bronze
- Noir ancien - Antik Schwarz



suspension



- E27 1x60W**
- 3357-40-102** Bianco - White
 - 3357-40-109** Bronzo - Bronze
 - 3357-40-349** Nero antico - Antique black
- Integrato - Integrated - Intégré - Integriert
 [Pagina - Page - Seite 467]
- CE

aragon LED

Design s.t. Fabas Luce

3357

Struttura in metallo e vetro in lastra - Metal frame and plate glass
 Monture en metal et verre plat - Metallgestell und Glas

- Blanc - Weiss



aragon 3357

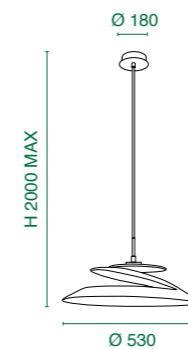

- LED Warm white 3000K - 18W - 1760 lm**
- 3357-42-102** Bianco - White
- LED dimmerabile a taglio di fase
 Phase cut dimmable LED
 LED dimmable à découpage de phase
 LED dimmbar (über Phasen- und abschnittsdimmer)
- Integrato - Integrated - Intégré - Integriert
 [Pagina - Page - Seite 467]
- CE

diana

Design s.t. Fabas Luce

2753

Struttura in metallo e vetro soffiato - Metal frame and blown glass
 Monture en metal et verre soufflé - Metallgestell und geblasenes Glas



suspension

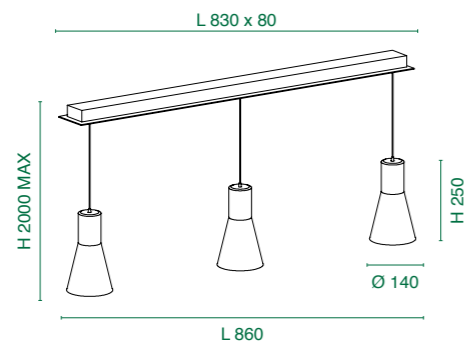

E27 3x60W

2753-47-138 Cromo - Chrome

CE IP20

Chromé - Verchromt

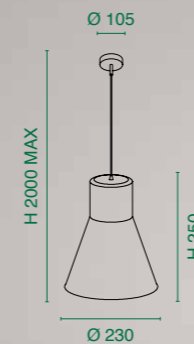

E27 1x60W

2753-45-138 Cromo - Chrome

CE IP20

diana 2753

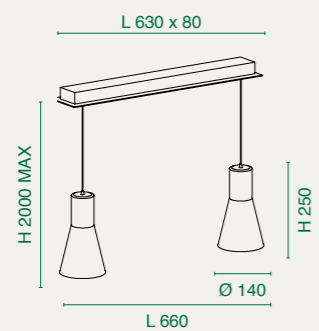

E27 2x60W

2753-46-138 Cromo - Chrome

CE IP20

Chromé - Verchromt

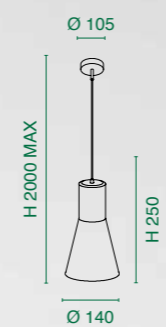

E27 1x60W

2753-40-138 Cromo - Chrome

CE IP20

provenza

Design s.t. Fabas Luce

2907

Blanc - Weiss

Struttura in metallo e vetro centrifugato - Metal frame and centrifuged glass
 Monture en metal et verre centrifugé - Metallgestell und zentrifugiertes Glas



suspension

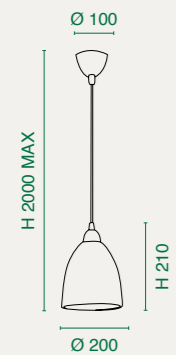

E27 1x60W
2907-44-102 Bianco - White
 Compatibile - Compatible - Kompatibel
 [Pagina - Page - Seite 467]
 CE

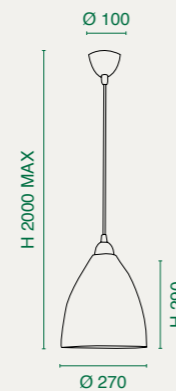

E27 1x60W
2907-45-102 Bianco - White
 Compatibile - Compatible - Kompatibel
 [Pagina - Page - Seite 467]
 CE

nice

Design s.t. Fabas Luce

2908

Blanc - Weiss

Struttura in metallo e vetro centrifugato - Metal frame and centrifuged glass
 Monture en metal et verre centrifuge - Metallgestell und zentrifugiertes Glas

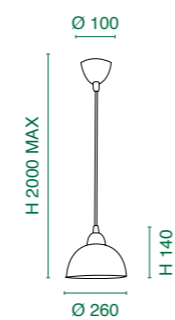

E27 1x60W
2908-44-102 Bianco - White
 Compatibile - Compatible - Kompatibel
 [Pagina - Page - Seite 467]
 CE

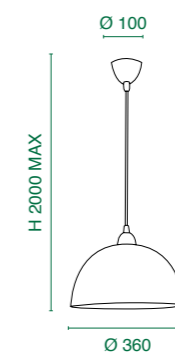

E27 1x60W
2908-45-102 Bianco - White
 Compatibile - Compatible - Kompatibel
 [Pagina - Page - Seite 467]
 CE

3697

Struttura in metallo e legno - Metal frame and wood
 Monture en métal et en bois - Metall und Holz

collection:

page
290



page
436

Blanc - Weiss



suspension



cordoba 3697

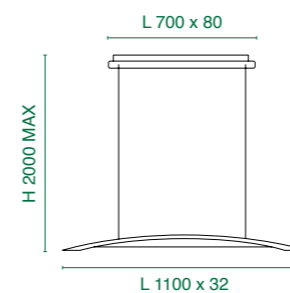

LED Warm white 3000K - 36W - 3880 lm

3697-40-102 Bianco - White

LED dimmerabile a taglio di fase
 Phase cut dimmable LED
 LED dimmable à découpage de phase
 LED dimmbar (über Phasen- und abschnittdimmer)

CE IP20



3676

Struttura in metallo, legno e diffusore in metacrilato - Metal and wood frame and methacrylate diffuser
 Monture en metal et bois et diffuseur en méthacrylate - Metall-und Holzgestell mit Methacrylatabdeckung

collection: **page 286**

Chêne - Eichenholz



suspension

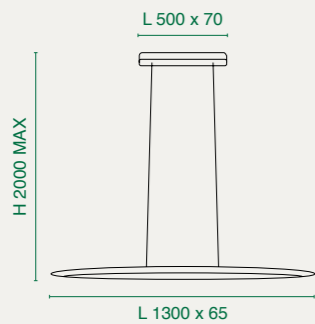

LED Warm white 3000K - 26W - 2945 lm

3676-45-215 Quercia - Oak

Regolazione luce con pulsante
 Push dimmer
 Bouton poussoir dimmable
 Tastdimmer

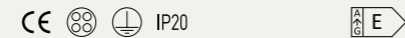

3695

Struttura in metallo e legno - Metal frame and wood
 Monture en métal et en bois - Metall und Holz

collection: **page 366**

Noir - Schwarz
 Blanc - Weiss



LED Warm white 3000K - 29W - 3020 lm

3695-40-101 Nero - Black

3695-40-102 Bianco - White

Dimmerabile a step
 Steps dimmable
 Gradable
 In Stufen dimmbar



Struttura in metallo e legno - Metal frame and wood
Monture en métal et en bois - Metall und Holz



suspension



pevero 3672

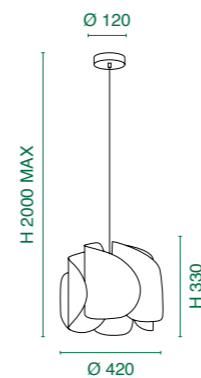

E27 1x40W
3672-40-132 Bois de frêne - Eschenholz
Frassino - Ash wood
CE



suspension

Chêne - Eichenholz



badia 3383

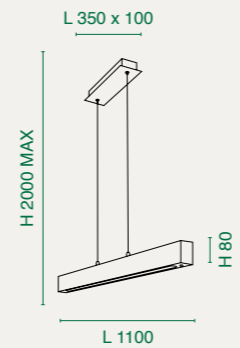

LED Warm white 3000K - 43W - 4320 lm

3383-40-215 Quercia - Oak

Regolazione luce con pulsante
 Push dimmer
 Bouton poussoir dimmable
 Tastdimmer

Compatibile - Compatible - Kompatibel
 [Pagina - Page - Seite 467]

IP20

3706

Struttura in metallo - Metal frame
Monture en métal - Metall



suspension





Noir - Schwarz Or mat - Gold edelmatt

E27 1x40W

3706-40-101 Nero - Black

3706-40-225 Oro opaco - Gold matt

CE    IP20

3670

Struttura in metallo e vetro soffiato - Metal frame and blown glass
Monture en métal et verre soufflé - Metallgestell und geblasenes Glas



suspension



Noir - Schwarz

homa 3670

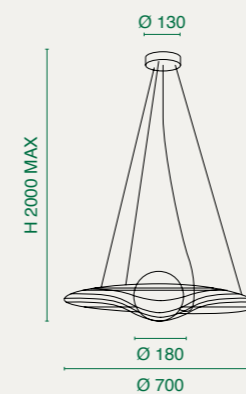

E27 1x40W

3670-45-101 ■ Nero - Black

Compatible - Compatible - Kompatibel
[Pagina - Page - Seite 467]

CE IP20

suspension



camp 3677

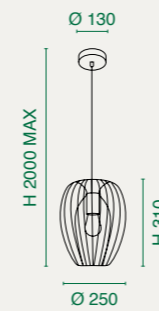

E27 1x40W

3677-40-101 Nero - Black

3677-40-102 Bianco - White

3677-40-225 Oro opaco - Gold matt

CE

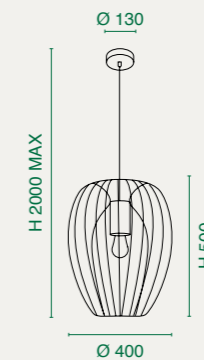

E27 1x40W

3677-45-101 Nero - Black

3677-45-102 Bianco - White

3677-45-225 Oro opaco - Gold matt

CE

Noir - Schwarz   Blanc - Weiss
 Or mat - Gold edelmatt 

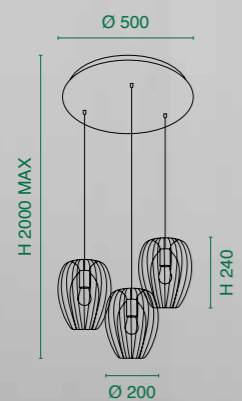



E27 3x40W

3677-47-101  Nero - Black

3677-47-102  Bianco - White

3677-47-225  Oro opaco - Gold matt

CE   IP20



lodge

Design s.t. Fabas Luce

3161

Struttura in alluminio - Aluminum frame
Monture en aluminium - Aluminium



suspension

Blanc - Weiss Brun foncé/Blanc - Dunkelbraun/Weiss



lodge 3161

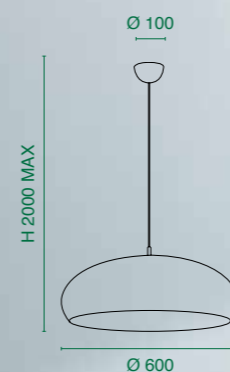

E27 1x60W

3161-45-102 Bianco - White

3161-45-251 Marrone scuro/Bianco
Dark brown/White

Compatibile - Compatible - Kompatibel
[Pagina - Page - Seite 467]

CE IP20

dingle Design s.t. Fabas Luce

3215

Struttura in metallo - Metal frame
Monture en métal - Metallgestell



suspension



Noir/Or - Schwarz/Gold

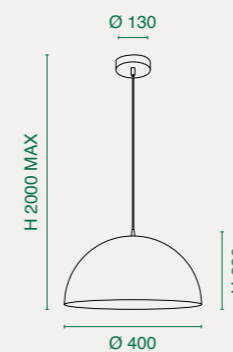

dingle 3215



E27 1x60W

3215-40-101 Nero/Oro - Black/Gold

Compatibile - Compatible - Kompatibel
[Pagina - Page - Seite 467]

CE   IP20

corvara Design s.t. Fabas Luce

3531

Struttura in metallo e ceramica - Metal and ceramic frame
Structure métal et céramique - Metall- und Keramikstruktur



suspension

Blanc - Weiss

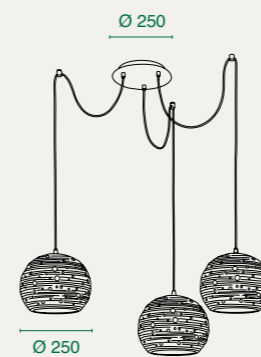

E27 3x40W

3531-47-102 Bianco - White

Compatibile - Compatible - Kompatibel
[Pagina - Page - Seite 467]

Lunghezza cavo 3000 mm
Length cable 3000 mm
Longueur cable 3000 mm
Kabellänge 3000 mm

CE IP20

3532

Struttura in metallo e ceramica - Metal and ceramic frame
 Structure métal et céramique - Metall- und Keramikstruktur



suspension

Blanc - Weiss Kaki - Khaki

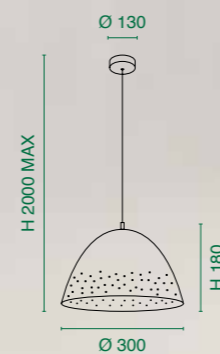

E27 1x40W

3532-40-102 Bianco - White

3532-40-348 Kaki - Khaki

Compatible - Compatible - Kompatibel
 [Pagina - Page - Seite 467]

CE IP20

casale 3532

duchessa

Design s.t. Fabas Luce

3533

Struttura in metallo e ceramica - Metal and ceramic structure
 Structure en métal et céramique - Metall- und Keramikstruktur



suspension

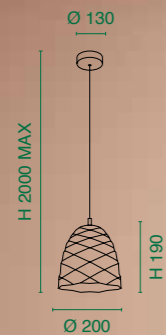

E27 1x40W

3533-40-102 Bianco - White

Compatibile - Compatible - Kompatibel
 [Pagina - Page - Seite 467]

CE

Blanc - Weiss



duchessa 3533

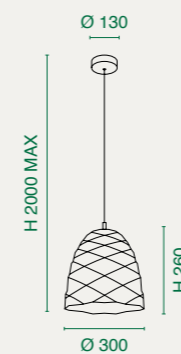

E27 1x40W

3533-45-102 Bianco - White

Compatibile - Compatible - Kompatibel
 [Pagina - Page - Seite 467]

CE

3534

Struttura in metallo e ceramica - Metal and ceramic frame
 Structure métal et céramique - Metall- und Keramikstruktur



suspension

Blanc - Weiss

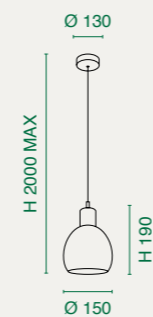

E27 1x40W

3534-40-102 Bianco - White

Compatibile - Compatible - Kompatibel
 [Pagina - Page - Seite 467]

IP20

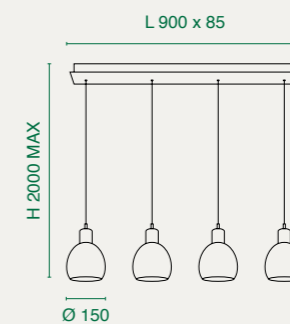

E27 4x40W

3534-49-102 Bianco - White

Compatibile - Compatible - Kompatibel
 [Pagina - Page - Seite 467]

IP20

crumple

Design s.t. Fabas Luce

3535

Struttura in metallo e ceramica - Metal and ceramic frame
Structure métal et céramique - Metall- und Keramikstruktur



suspension



Blanc - Weiss Kaki - Khaki

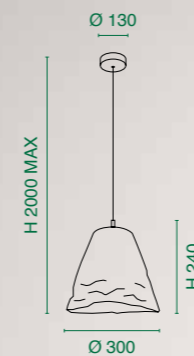

E27 1x40W

3535-40-102 Bianco - White

3535-40-348 Kaki - Khaki

Compatibile - Compatible - Kompatibel
[Pagina - Page - Seite 467]

CE IP20

crumple 3535

3757

Struttura in metallo e plastica vegetale - Metal frame and bio-based plastic
 Monture en métal et plastique végétal - Metall und biobasierter Kunststoff



suspension

- Blanc - Weiss
- Bordeaux
- Couleur moutard - Senffarbe



Prodotto realizzato con stampanti 3D utilizzando plastica biologica PLA.
 Product made with 3D printers using PLA biological plastic.
 Produit fabriqué avec des imprimantes 3D utilisant du plastique biosourcé PLA.
 Produkt hergestellt mit 3D-Druckern aus biobasiertem PLA-Kunststoff.



- E27 1x10W**
- 3757-40-102** Bianco - White
 - 3757-40-133** Bordeaux - Burgundy
 - 3757-40-367** Senape - Mustard colored
- CE IP20

carola 3757

cone

Design s.t. Fabas Luce

3758

Struttura in metallo e plastica vegetale - Metal frame and bio-based plastic
 Monture en métal et plastique végétal - Metall und biobasierter Kunststoff

- Blanc - Weiss
- Bordeaux
- Orange
- Couleur moutard - Senffarbe

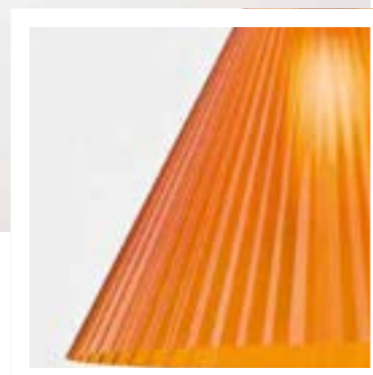

Prodotto realizzato con stampanti 3D utilizzando plastica biologica PLA.

Product made with 3D printers using PLA biological plastic.

Produit fabriqué avec des imprimantes 3D utilisant du plastique biosourcé PLA.

Produkt hergestellt mit 3D-Druckern aus biobasiertem PLA-Kunststoff.

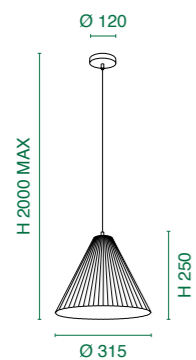

E27 1x10W

3758-40-102 Bianco - White

3758-40-133 Bordeaux - Burgundy

3758-40-170 Arancio - Orange

3758-40-367 Senape - Mustard colored

CE IP20

suspension

cone 3758



3759

Struttura in metallo e plastica vegetale - Metal frame and bio-based plastic
 Monture en métal et plastique végétal - Metall und biobasierter Kunststoff



suspension

- Blanc - Weiss
- Bordeaux
- Couleur moutard - Senffarbe

Prodotto realizzato con stampanti 3D utilizzando plastica biologica PLA.

Product made with 3D printers using PLA biological plastic.

Produit fabriqué avec des imprimantes 3D utilisant du plastique biosourcé PLA.

Produkt hergestellt mit 3D-Druckern aus biobasiertem PLA-Kunststoff.



lisa 3759

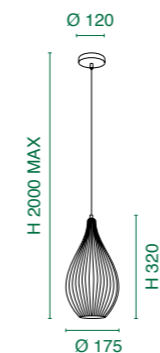

E27 1x10W

3759-40-102 Bianco - White

3759-40-133 Bordeaux - Burgundy

3759-40-367 Senape - Mustard colored

CE IP20

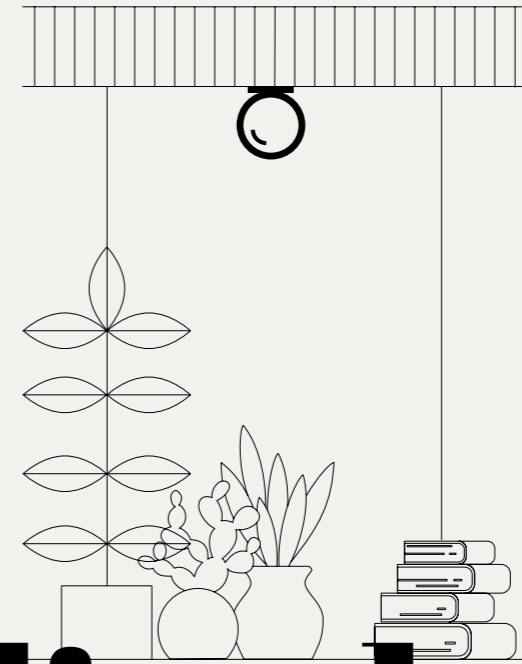

ceiling lamp



ceiling lamp

Modalità semplice per selezionare la temperatura colore.
 Simple way to select the color temperature.
 Un moyen simple de sélectionner la température de couleur.
 Einfache Möglichkeit, die Farbtemperatur auszuwählen.



lunar 3800

LED Warm white - Natural white 26W - 3150 lm

3800-65-101 Nero - Black

3800-65-102 Bianco - White

Dimmerabile a step
 Steps dimmable
 Gradable
 In Stufen dimmbar

2700K - 3000K - 4000K

CE IP20

E

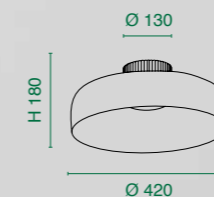

3798

Struttura in metallo e metacrilato - Metal and methacrylate frame
Monture en métal et méthacrylate - Metall - und Methacrylatgestell

ceiling lamp



Blanc - Weiss Sable - Sandfarben



conrad 3798

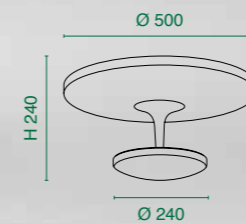

LED Warm white 3000K - 36W - 4200 lm

3798-65-102 Bianco - White

3798-65-355 Sabbia - Sand

Dimmerabile a step
Steps dimmable
Gradable
In Stufen dimmbar

CE IP20

E



ceiling lamp

- Noir - Schwarz
- Blanc - Weiss
- Laiton satiné - Messing satiniert



Regolazione della temperatura di colore tramite una levetta posta sul lato esterno della plafoniera.
 Adjustment of color temperature on the external side of the ceiling lamp.
 Réglage de la température de couleur à l'extérieur du plafonnier.
 Einstellung der Farbtemperatur an der Außenseite der Deckenleuchte.

quirk 3789

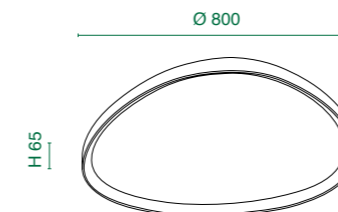

LED Warm white - Natural white 75W - 8900 lm

3789-64-101 Nero - Black

3789-64-102 Bianco - White

3789-64-119 Ottone satinato - Satined brass



Dimmerabile a step
 Steps dimmable
 Gradable
 In Stufen dimmbar

2700K - 3200K - 4000K

CE IP20





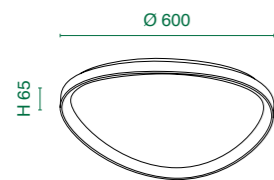

Noir - Schwarz  Blanc - Weiss 
Laiton satiné - Messing satiniert 





LED Warm white - Natural white 56W - 6600 lm



3789-65-101  Nero - Black

3789-65-102  Bianco - White

3789-65-119  Ottone satinato - Satined brass

 Dimmerabile a step
Steps dimmable
Gradable
In Stufen dimmbar

 2700K - 3200K - 4000K

CE   IP20





LED Warm white - Natural white 38W - 4400 lm



3789-61-101  Nero - Black

3789-61-102  Bianco - White

3789-61-119  Ottone satinato - Satined brass

 Dimmerabile a step
Steps dimmable
Gradable
In Stufen dimmbar

 2700K - 3200K - 4000K

CE   IP20



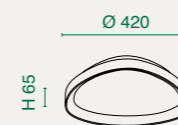

Struttura in metallo e metacrilato - Metal and methacrylate frame
Monture en métal et méthacrylate - Metall- und Methacrylatgestell



ceiling lamp



■ Noir - Schwarz
□ Blanc - Weiss

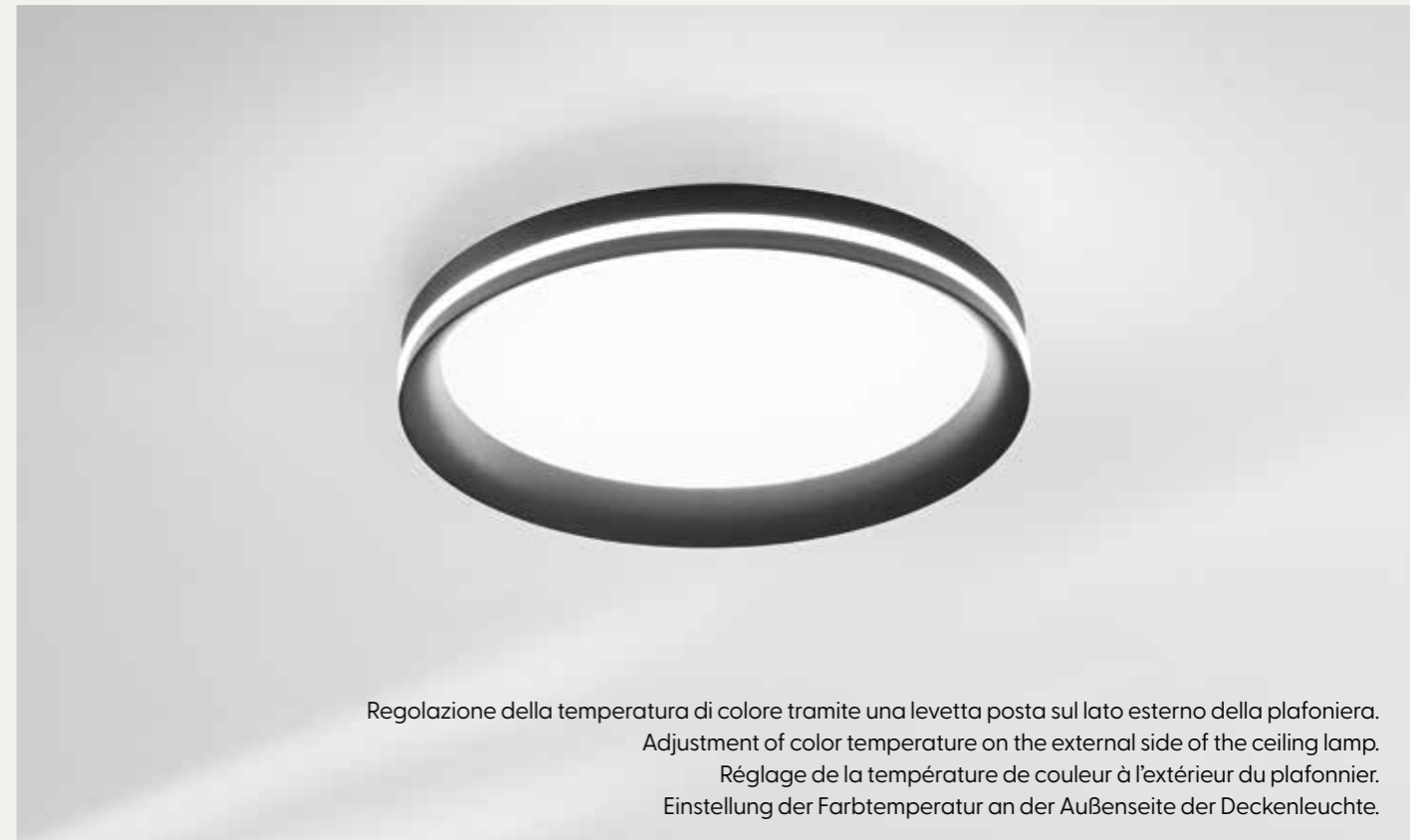

isy 3788



LED Warm white - Natural white 42W - 4000 lm

3788-61-101 ■ Nero - Black

3788-61-102 □ Bianco - White

Dimmerabile a step
Steps dimmable
Gradable
In Stufen dimmbar

2700K - 3200K - 4000K

CE IP20



Noir - Schwarz  Blanc - Weiss 

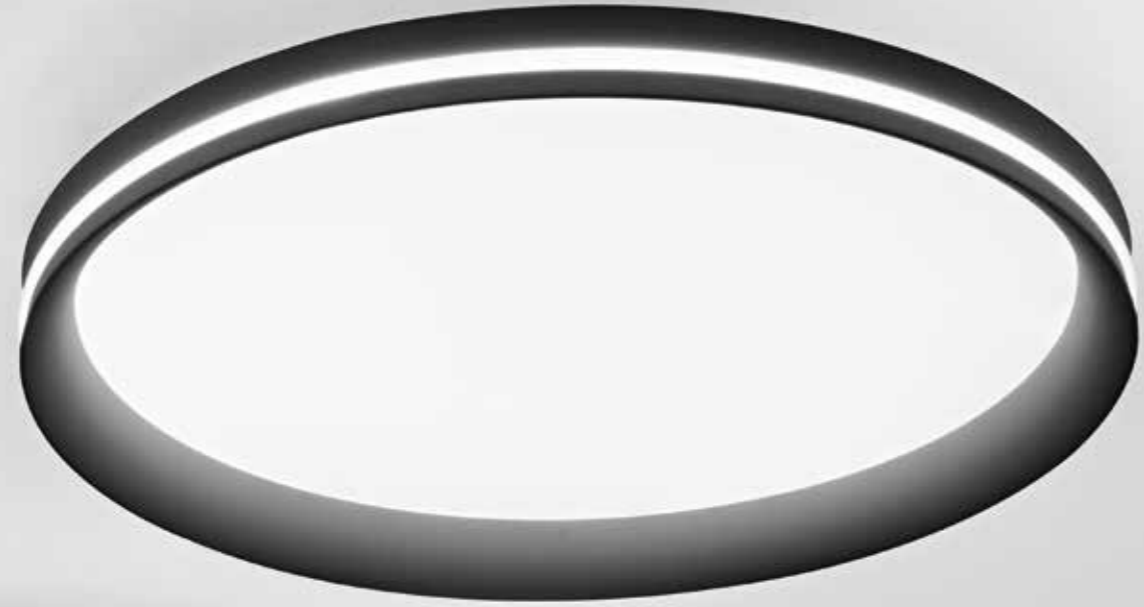

ceiling lamp



isy 3788

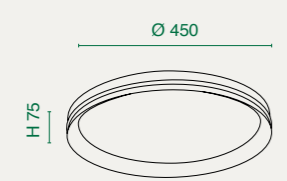

LED Warm white - Natural white 52W - 4900 lm

3788-65-101  Nero - Black

3788-65-102  Bianco - White

 Dimmerabile a step
Steps dimmable
Gradable
In Stufen dimmbar

 2700K - 3200K - 4000K

CE   IP20 



LED Warm white - Natural white 64W - 5800 lm

3788-64-101  Nero - Black

3788-64-102  Bianco - White

 Dimmerabile a step
Steps dimmable
Gradable
In Stufen dimmbar

 2700K - 3200K - 4000K

CE   IP20 

3755

Struttura in metallo e vetro borosilicato - Metal frame and borosilicate glass
 Monture en métal et verre borosilicaté - Metall und Borsilicatglas

collection: page 30

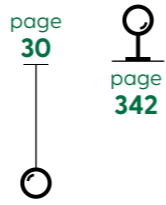

page 342

Transparent Cognac

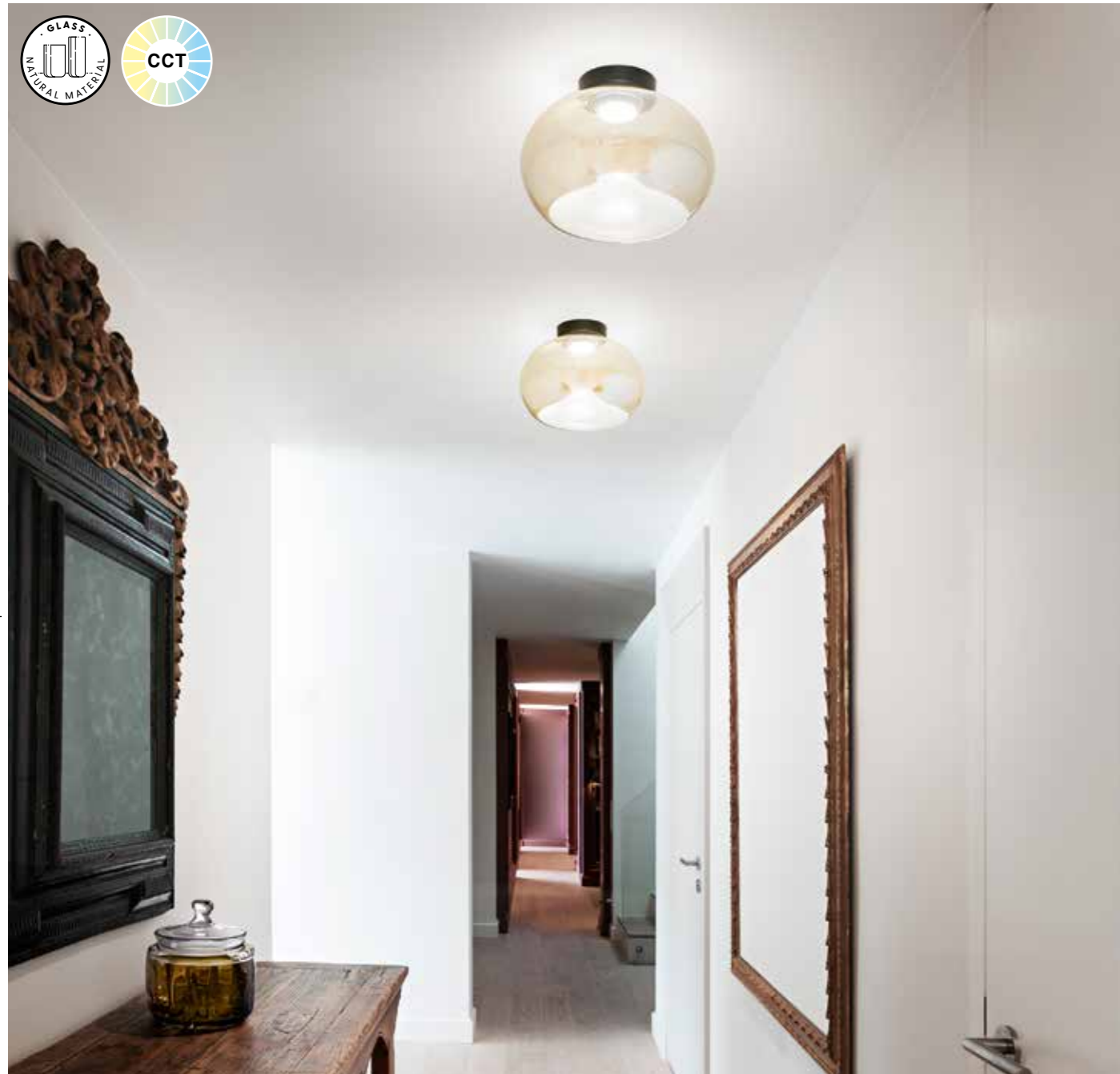

ceiling lamp

Modalità semplice per selezionare la temperatura colore.
 Simple way to select the color temperature.
 Un moyen simple de sélectionner la température de couleur.
 Einfache Möglichkeit, die Farbtemperatur auszuwählen.



brena 3755

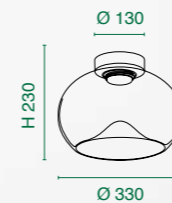

LED Warm white - Natural white 19W - 2100 lm

3755-65-241 Trasparente - Transparent

3755-65-365 Cognac

Dimmerabile a step
 Steps dimmable
 Gradable
 In Stufen dimmbar

2700K - 3000K - 4000K

CE

E



yuko Design s.t. Fabas Luce
3803

Struttura in metallo e metacrilato - Metal and methacrylate frame
Monture en métal et méthacrylate - Metall- und Methacrylatgestell

collection: **page 26**

26



Feuille or/Noir - Blattgold/Schwarz   Blanc - Weiss

ceiling lamp

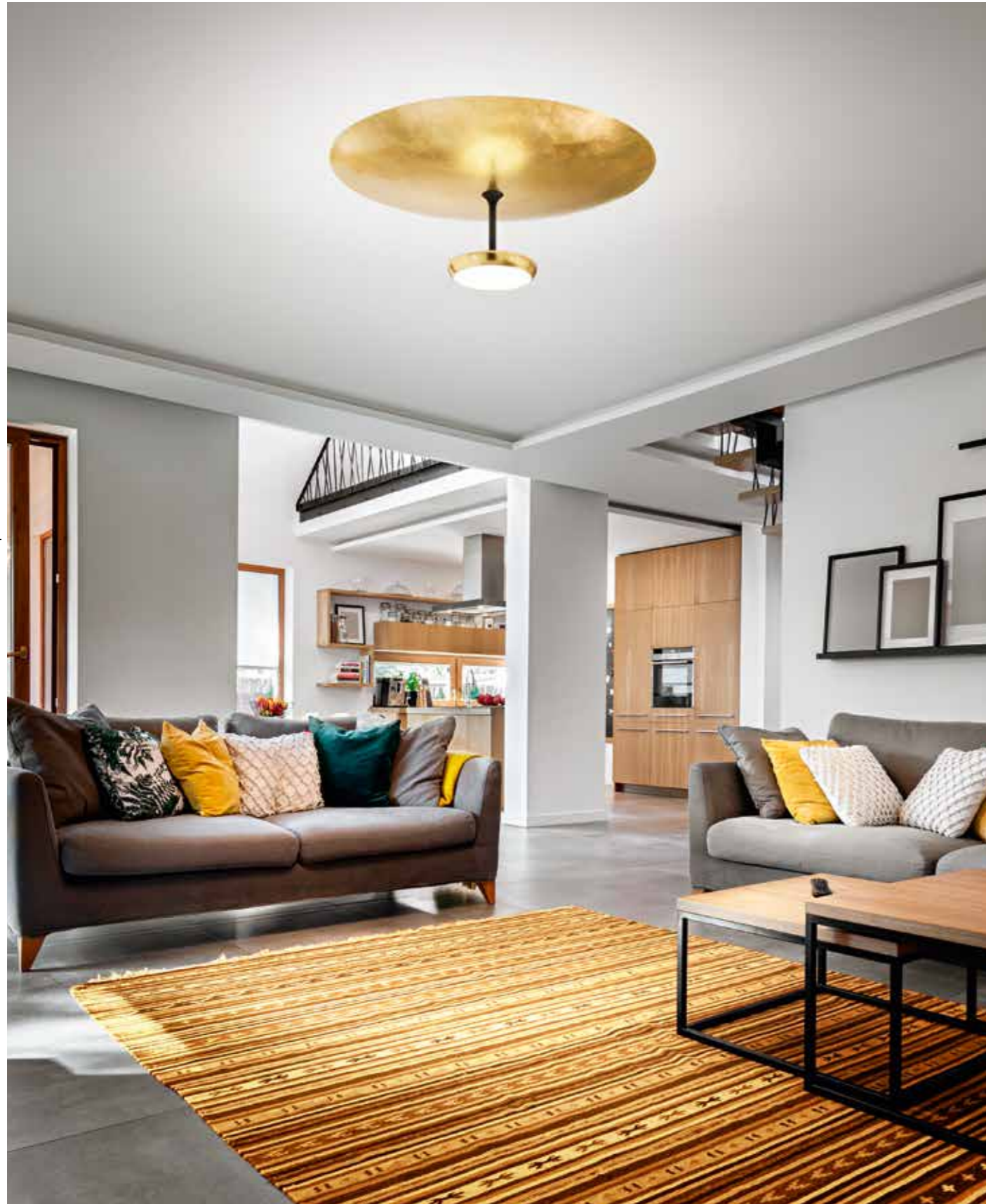

yuko 3803

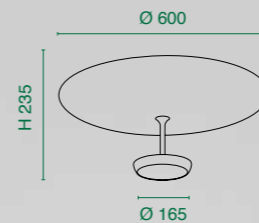



LED Warm white 3000K - 40W - 3200 lm

3803-65-102  Bianco - White

3803-65-294  Foglia oro/Noir - Gold Leaf/Black

Dimmerabile a step
Steps dimmable
Gradable
In Stufen dimmbar

CE   IP20



3767

Struttura in metallo e vetro borosilicato - Metal frame and borosilicate glass
 Monture en métal et verre borosilicaté - Metall und Borsilicatglas

collection: **page 62**

Blanc - Weiss Cognac



ceiling lamp



kino 3767

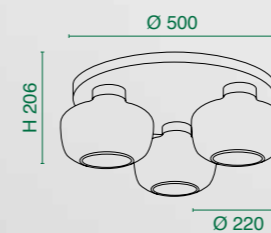

LED Warm white 3000K - 36W - 3900 lm

3767-65-102 Bianco - White

3767-65-365 Cognac

Dimmerabile a step
 Steps dimmable
 Gradable
 In Stufen dimmbar

CE IP20

E



3481

Struttura in metallo e vetro borosilicato - Metal frame and borosilicate glass
 Monture en métal et verre borosilicaté - Metall und Borsilicatglas

collection: **page 108**



ceiling lamp

Ambre - Amber  Gris transparent - Grau transparent 
 Transparent 





lila 3481





E27 1x40W

3481-61-125  Ambra - Amber

3481-61-126  Fumé - Transparent grey

3481-61-241  Trasparente - Transparent

CE    IP20



- Ambre - Amber
- Gris transparent - Grau transparent
- Transparent

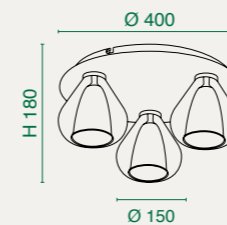

E14 3x40W

3481-65-125 Ambra - Amber

3481-65-126 Fumé - Transparent grey

3481-65-241 Trasparente - Transparent

CE IP20

aragon LED

Design s.t. Fabas Luce

3357

Struttura in metallo e vetro in lastra - Metal frame and plate glass
Monture en metal et verre plat - Metallgestell und Glas

collection: **page 145**

page 145



Blanc - Weiss



ceiling lamp

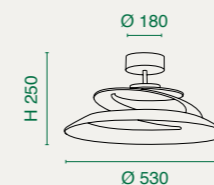

LED Warm white 3000K - 18W - 1760 lm

3357-65-102 Bianco - White

LED dimmerabile a taglio di fase
Phase cut dimmable LED
LED dimmable à découpage de phase
LED dimmbar (über Phasen- und abschnittdimmer)

 Integrato - Integrated - Intégré - Integriert
[Pagina - Page - Seite 467]

CE   IP20



3463

Struttura in metallo e vetro soffiato - Metal frame and blown glass
 Monture en métal et verre soufflé - Metallgestell und geblasenes Glas



ceiling lamp



Ambre - Amber ■ Gris transparent - Grau transparent ■



vintage 3463

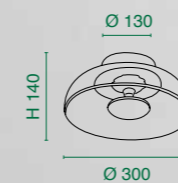

LED Warm white 3000K - 15W - 1510 lm

3463-61-125 ■ Ambra - Amber

3463-61-126 ■ Fumé - Transparent grey

LED dimmerabile a taglio di fase
 Phase cut dimmable LED
 LED dimmable à découpage de phase
 LED dimmbar (über Phasen- und abschnitt-dimmer)

Compatible - Compatible - Kompatibel
 [Pagina - Page - Seite 467]

CE IP20





Montaggio a parete o soffitto
Wall or ceiling mounting
Montage au mur ou au plafond
Wand- oder Deckenmontage

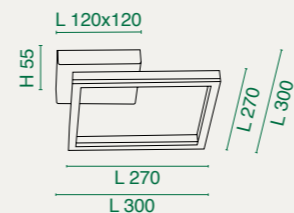

- Noir - Schwarz
- Blanc - Weiss
- Or mat - Gold edelmatt
- Antracite - Anthrazit
- Corten - Rostbraun



LED Warm white 3000K - 22W - 2160 lm

3394-21-101 Nero - Black

3394-21-102 Bianco - White

3394-21-225 Oro opaco - Gold matt

3394-21-282 Antracite - Anthracite

3394-21-361 Corten - Rostbraun

LED dimmerabile a taglio di fase
Phase cut dimmable LED
LED dimmable à découpage de phase
LED dimmbar (über Phasen- und abschnittdimmer)

Integrato - Integrated - Intégré - Integriert
[Pagina - Page - Seite 467]

CE IP20

LED Natural white 4000K - 22W - 2250 lm

3394-23-102 Bianco - White

3394-23-282 Antracite - Anthracite

LED dimmerabile a taglio di fase
Phase cut dimmable LED
LED dimmable à découpage de phase
LED dimmbar (über Phasen- und abschnittdimmer)

Integrato - Integrated - Intégré - Integriert
[Pagina - Page - Seite 467]

CE IP20



- Noir - Schwarz Blanc - Weiss
- Or mat - Gold edelmatt Anthracite - Anthrazit
- Corten - Rostbraun

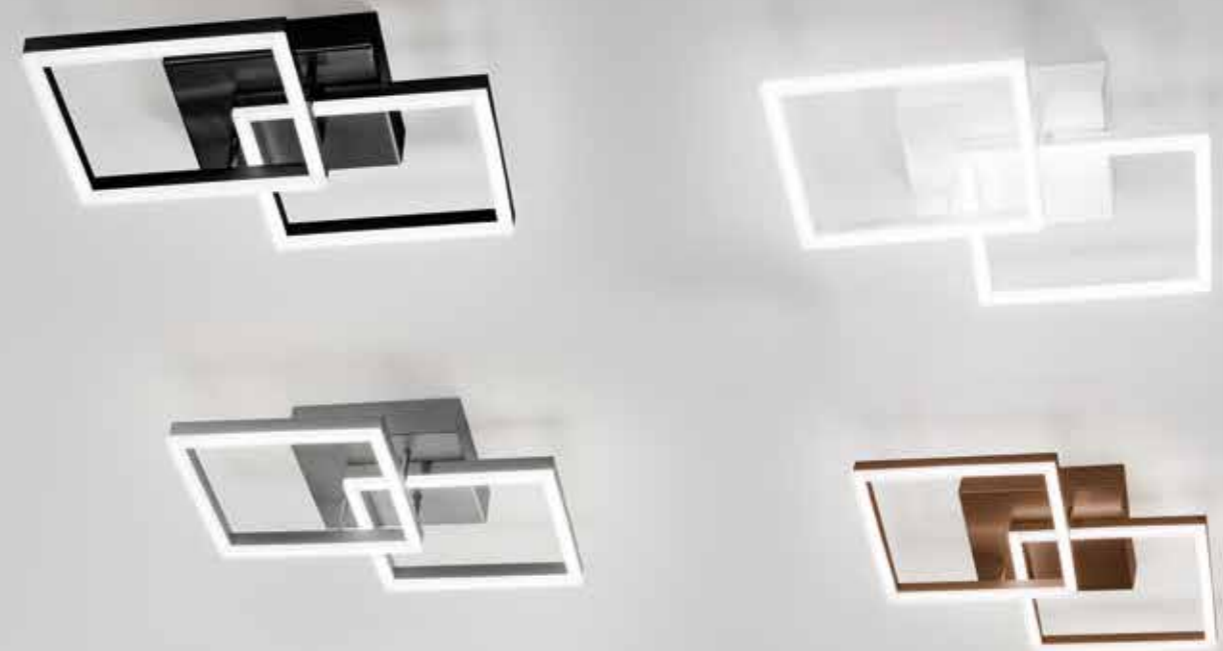

Montaggio a parete o soffitto
Wall or ceiling mounting
Montage au mur ou au plafond
Wand- oder Deckenmontage

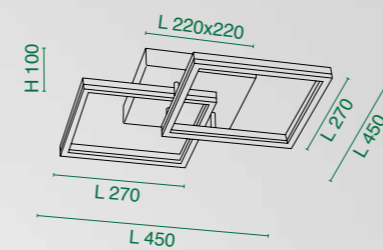

LED Warm white 3000K - 39W - 3880 lm

3394-22-101 Nero - Black

3394-22-102 Bianco - White

3394-22-225 Oro opaco - Gold matt

3394-22-282 Anthracite - Anthracite

3394-22-361 Corten - Rostbraun

LED dimmerabile a taglio di fase
Phase cut dimmable LED
LED dimmable à découpage de phase
LED dimmbar (über Phasen- und abschnittsdimmer)

Integrato - Integrated - Intégré - Integriert
[Pagina - Page - Seite 467]

CE

LED Natural white 4000K - 39W - 4050 lm

3394-29-102 Bianco - White

3394-29-282 Anthracite - Anthracite

LED dimmerabile a taglio di fase
Phase cut dimmable LED
LED dimmable à découpage de phase
LED dimmbar (über Phasen- und abschnittsdimmer)

Integrato - Integrated - Intégré - Integriert
[Pagina - Page - Seite 467]

CE

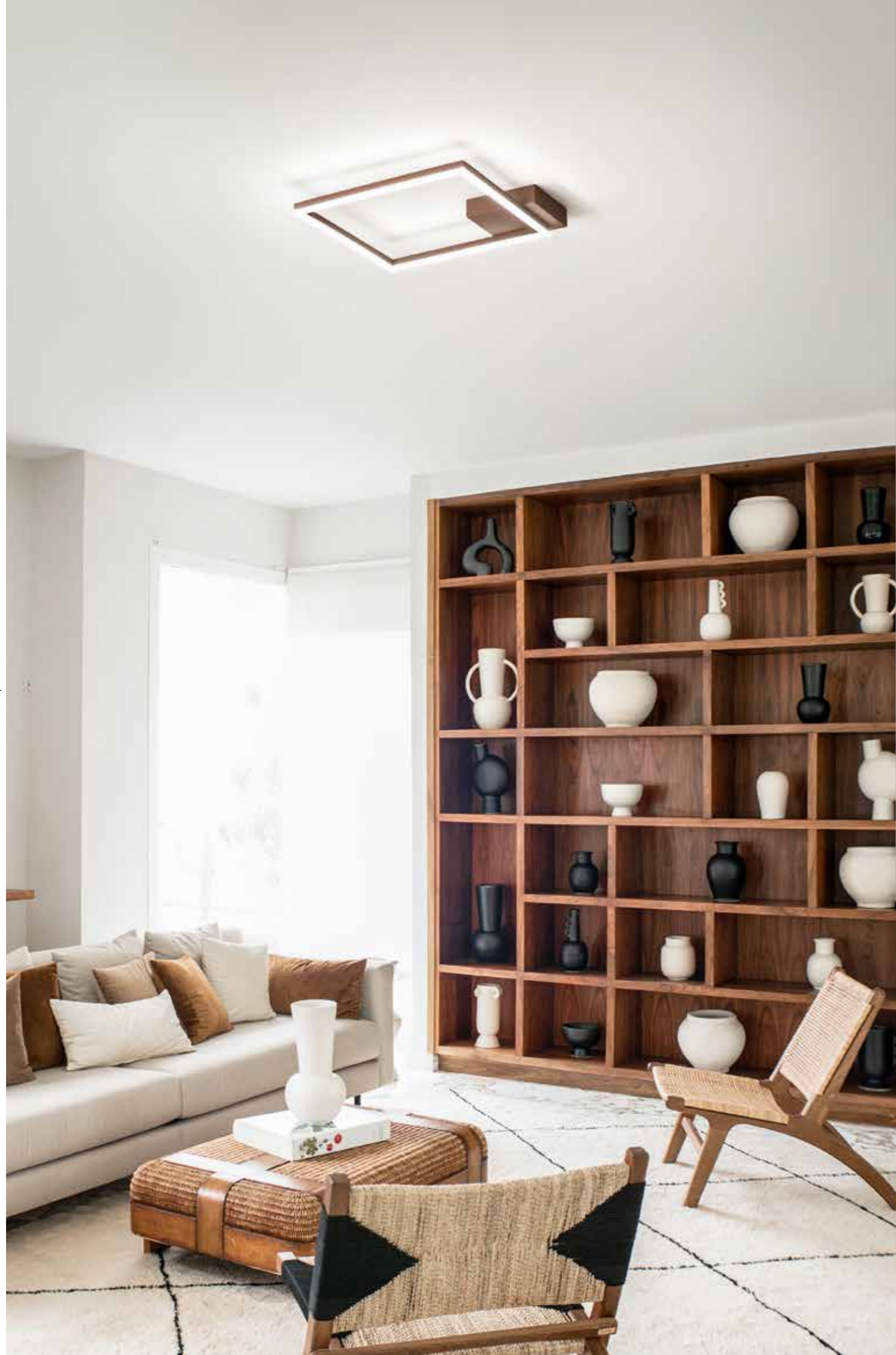

- Noir - Schwarz Blanc - Weiss
- Or mat - Gold edelmatt Anthracite - Anthrazit
- Corten - Rostbraun

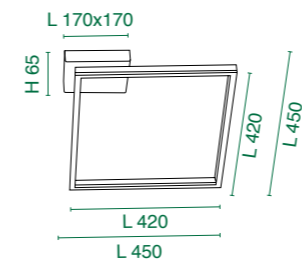

LED Warm white 3000K - 39W - 3880 lm

3394-61-101 Nero - Black

3394-61-102 Bianco - White

3394-61-225 Oro opaco - Gold matt

3394-61-282 Anthracite - Anthracite

3394-61-361 Corten - Rostbraun

LED dimmerabile a taglio di fase
Phase cut dimmable LED
LED dimmable à découpage de phase
LED dimmbar (über Phasen- und abschnittdimmer)

Integrato - Integrated - Intégré - Integriert
[Pagina - Page - Seite 467]

CE IP20

E

LED Natural white 4000K - 39W - 4050 lm

3394-62-102 Bianco - White

3394-62-282 Anthracite - Anthracite

LED dimmerabile a taglio di fase
Phase cut dimmable LED
LED dimmable à découpage de phase
LED dimmbar (über Phasen- und abschnittdimmer)

Integrato - Integrated - Intégré - Integriert
[Pagina - Page - Seite 467]

CE IP20

E



- Noir - Schwarz Blanc - Weiss
- Or mat - Gold edelmatt Anthracite - Anthrazit
- Corten - Rostbraun

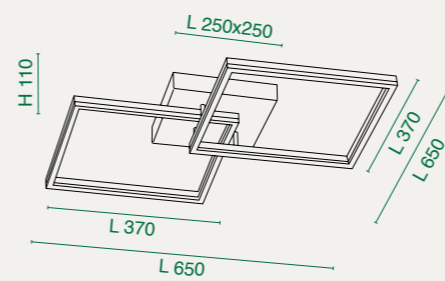
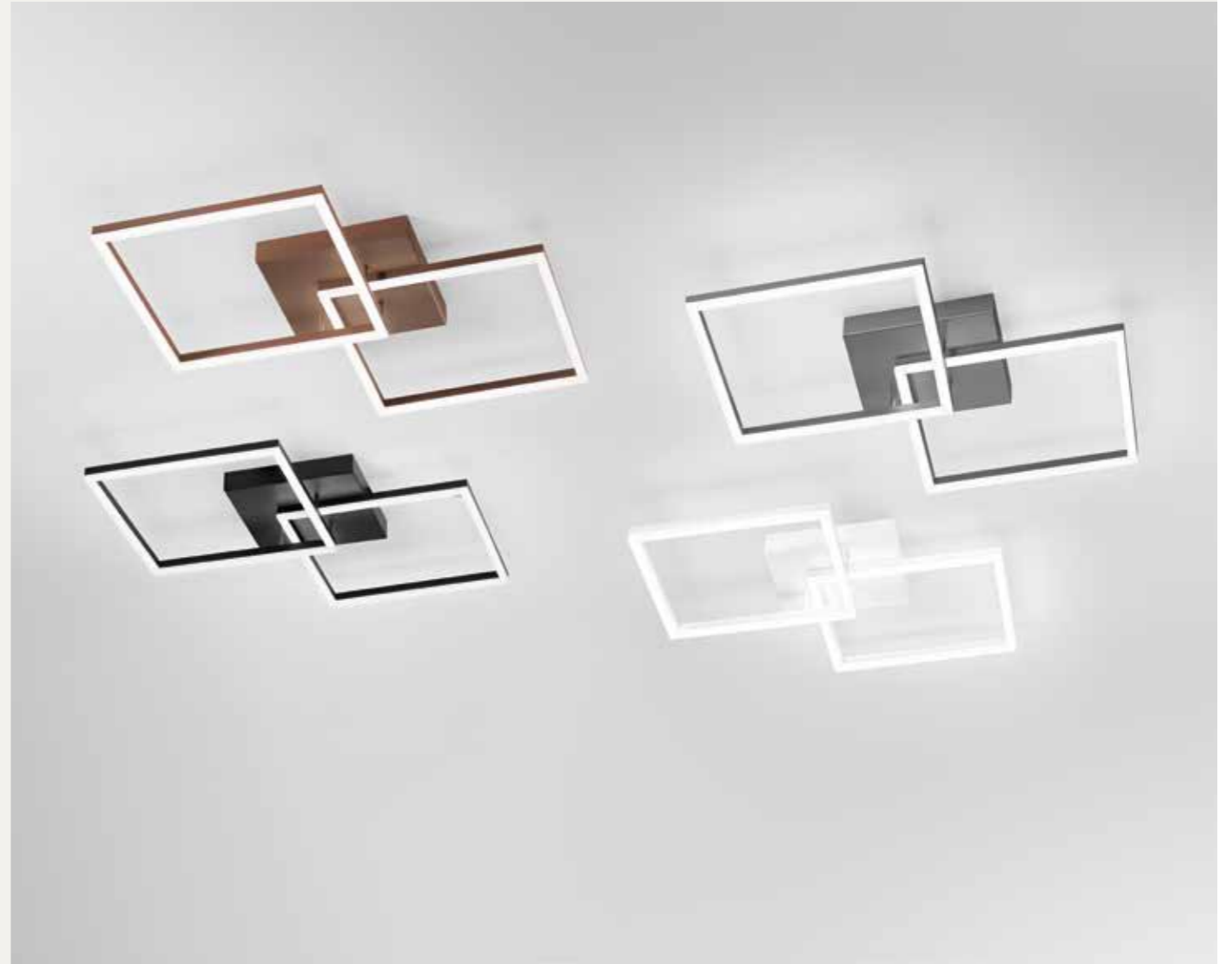

LED Warm white 3000K - 52W - 5180 lm

- 3394-65-101** Nero - Black
- 3394-65-102** Bianco - White
- 3394-65-225** Oro opaco - Gold matt
- 3394-65-282** Anthracite - Anthracite
- 3394-65-361** Corten - Rostbraun

LED dimmerabile a taglio di fase
Phase cut dimmable LED
LED dimmable à découpage de phase
LED dimmbar (über Phasen- und abschnittsdimmer)

Integrato - Integrated - Intégré - Integriert
[Pagina - Page - Seite 467]

CE IP20

LED Natural white 4000K - 52W - 5400 lm

- 3394-66-102** Bianco - White
- 3394-66-282** Anthracite - Anthracite

LED dimmerabile a taglio di fase
Phase cut dimmable LED
LED dimmable à découpage de phase
LED dimmbar (über Phasen- und abschnittsdimmer)

Integrato - Integrated - Intégré - Integriert
[Pagina - Page - Seite 467]

CE IP20

giotto

Design s.t. Fabas Luce

3508

Struttura in metallo e metacrilato - Metal and methacrylate frame
Monture en métal et méthacrylate - Metall - und Methacrylatgestell

collection:

page
88

page
272

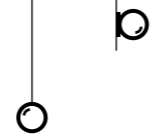

Noir - Schwarz Blanc - Weiss

ceiling lamp





giotto 3508



LED Warm white 3000K - 36W - 3780 lm

3508-61-101 Nero - Black

3508-61-102 Bianco - White

 LED dimmerabile a taglio di fase
Phase cut dimmable LED
LED dimmable à découpage de phase
LED dimmbar (über Phasen- und abschnittsdimmer)

 Integrato - Integrated - Intégré - Integriert
[Pagina - Page - Seite 467]

CE   IP20

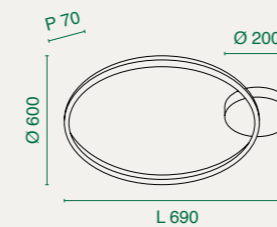

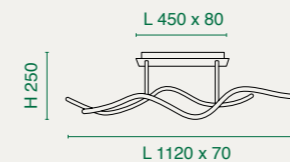

LED Warm white 3000K - 36W - 3880 lm

3666-65-101 Nero - Black

3666-65-102 Bianco - White

Dimmerabile a step
 Steps dimmable
 Gradable
 In Stufen dimmbar

CE IP20

3706

Struttura in metallo - Metal frame
Monture en métal - Metall

collection: page 160

160



ceiling lamp



Noir - Schwarz  Or mat - Gold edelmatt 



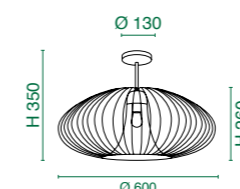

fassa 3706



E27 1x40W

3706-65-101  Nero - Black

3706-65-225  Oro opaco - Gold matt

CE    IP20

3625

Struttura in metallo e metacrilato - Metal and methacrylate frame
 Monture en métal et méthacrylate - Metall- und Methacrylatgestell

collection:

page
104



page
374

page
430

ceiling lamp



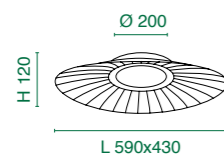

vela 3625





LED Warm white 3000K - 24W - 4000 lm

3625-61-102 Bianco - White

-  LED dimmerabile a taglio di fase
- Phase cut dimmable LED
-  LED dimmable à découpage de phase
- LED dimmbar (über Phasen- und abschnittdimmer)

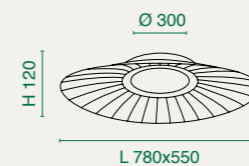

 Integrato - Integrated - Intégré - Integriert
 [Pagina - Page - Seite 467]

CE   IP20 





LED Warm white 3000K - 40W - 5400 lm

3625-65-102 Bianco - White

-  LED dimmerabile a taglio di fase
- Phase cut dimmable LED
-  LED dimmable à découpage de phase
- LED dimmbar (über Phasen- und abschnittdimmer)

 Integrato - Integrated - Intégré - Integriert
 [Pagina - Page - Seite 467]

CE   IP20 

graff E27

Design s.t. Fabas Luce

3209

Blanc - Weiss

Struttura in metallo e vetro soffiato - Metal frame and blown glass
 Monture en métal et verre soufflé - Metallgestell und geblasenes Glas



ceiling lamp

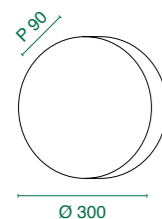

E27 1x60W
3209-61-102 Bianco - White
 Turn&Lock
 Compatibile - Compatible - Kompatibel
 [Pagina - Page - Seite 467]
 CE

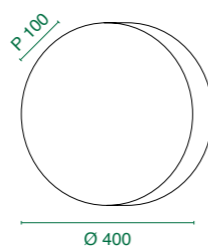

E27 2x60W
3209-65-102 Bianco - White
 Turn&Lock
 Compatibile - Compatible - Kompatibel
 [Pagina - Page - Seite 467]
 CE

graff LED

Design s.t. Fabas Luce

3567

Blanc - Weiss

Struttura in metallo e vetro soffiato - Metal frame and blown glass
 Monture en métal et verre soufflé - Metallgestell und geblasenes Glas



graff 3209 - 3567

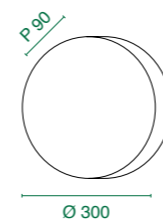

LED Warm white 3000K - 18W - 1980 lm
3567-61-102 Bianco - White
 Turn&Lock
 LED dimmerabile a taglio di fase
 Phase cut dimmable LED
 LED dimmable à découpage de phase
 LED dimmbar (über Phasen-an- und abschnittdimmer)
 CE

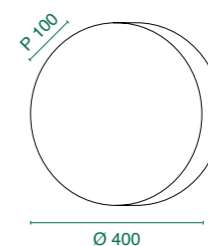

LED Warm white 3000K - 24W - 2950 lm
3567-65-102 Bianco - White
 Turn&Lock
 LED dimmerabile a taglio di fase
 Phase cut dimmable LED
 LED dimmable à découpage de phase
 LED dimmbar (über Phasen-an- und abschnittdimmer)
 CE

pandora E27

Design s.t. Fabas Luce

2433

collection: **page 296**

Blanc - Weiss

Struttura in metallo e vetro soffiato - Metal frame and blown glass
 Monture en métal et verre soufflé - Metallgestell und geblasenes Glas



ceiling lamp



E27 2x75W

2433-64-102 Bianco - White

Turn&Lock

Compatible - Compatible - Kompatibel
 [Pagina - Page - Seite 467]

CE IP20

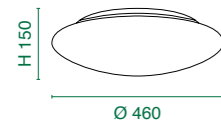

E27 2x40W

2433-65-102 Bianco - White

Turn&Lock

Compatible - Compatible - Kompatibel
 [Pagina - Page - Seite 467]

CE IP20

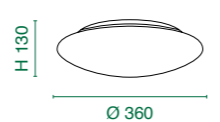

E27 1x60W

2433-61-102 Bianco - White

Turn&Lock

Compatible - Compatible - Kompatibel
 [Pagina - Page - Seite 467]

CE IP20



E27 1x60W

2433-69-102 Bianco - White

Turn&Lock

Compatible - Compatible - Kompatibel
 [Pagina - Page - Seite 467]

CE IP20

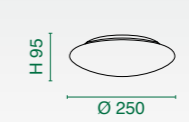

pandora E27 sensor

Design s.t. Fabas Luce

3222

Struttura in metallo e vetro soffiato - Metal frame and blown glass
 Monture en metal et verre soufflé - Metallgestell und geblasenes Glas

Blanc - Weiss 



ceiling lamp

pandora LED

Design s.t. Fabas Luce

3563

Struttura in metallo e vetro soffiato - Metal frame and blown glass
 Monture en metal et verre soufflé - Metallgestell und geblasenes Glas

Blanc - Weiss 



pandora 3222 - 3563



E27 1x60W

3222-61-102  Bianco - White

 Turn&Lock

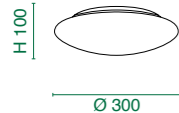
 Sensore di movimento
 Motion sensor
 Capteur de mouvement
 Bewegungssensor



CE   IP20



E27 2x40W

3222-65-102  Bianco - White

 Turn&Lock

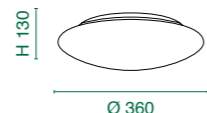
 Sensore di movimento
 Motion sensor
 Capteur de mouvement
 Bewegungssensor



CE   IP20



LED Warm white 3000K - 18W - 1980 lm

3563-61-102  Bianco - White

 Turn&Lock

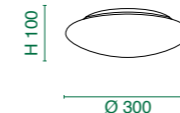
 LED dimmerabile a taglio di fase
 Phase cut dimmable LED
 LED dimmable à découpage de phase
 LED dimmbar (über Phasen- und abschnitt-dimmer)



CE   IP20 

LED Warm white 3000K - 24W - 2950 lm

3563-65-102  Bianco - White

 Turn&Lock

 LED dimmerabile a taglio di fase
 Phase cut dimmable LED
 LED dimmable à découpage de phase
 LED dimmbar (über Phasen- und abschnitt-dimmer)

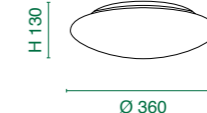

CE   IP20 

osaka E27

Design s.t. Fabas Luce

2867

Struttura in metallo e vetro in lastra - Metal frame and plate glass
 Monture en metal et verre plat - Metallgestell und Glas

- Blanc - Weiss
- Chromé - Verchromt
- Nichel satiné - Nickel satiniert



ceiling lamp

osaka LED

Design s.t. Fabas Luce

3565

Struttura in metallo e vetro in lastra - Metal frame and plate glass
 Monture en metal et verre plat - Metallgestell und Glas

- Blanc - Weiss
- Chromé - Verchromt
- Nichel satiné - Nickel satiniert



osaka 2867 - 3565

E27 2x42W

2867-61-102 Bianco - White

2867-61-138 Cromo - Chrome

2867-61-178 Nichel satinato
Satined nickel

Compatibile - Compatible - Kompatibel
 [Pagina - Page - Seite 467]

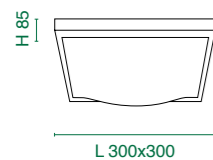
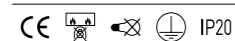

E27 3x42W

2867-66-102 Bianco - White

2867-66-138 Cromo - Chrome

2867-66-178 Nichel satinato
Satined nickel

Compatibile - Compatible - Kompatibel
 [Pagina - Page - Seite 467]

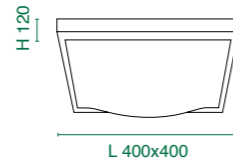
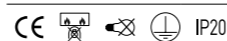

LED Warm white 3000K - 12W - 1100 lm

3565-61-102 Bianco - White

3565-61-138 Cromo - Chrome

3565-61-178 Nichel satinato
Satined nickel

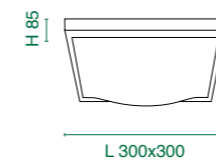

LED Warm white 3000K - 24W - 2400 lm

3565-65-102 Bianco - White

3565-65-138 Cromo - Chrome

3565-65-178 Nichel satinato
Satined nickel

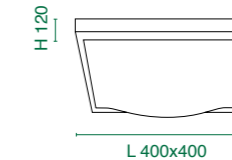

plaza E27

Design s.t. Fabas Luce

2866

Struttura in metallo e vetro in lastra - Metal frame and plate glass
 Monture en metal et verre plat - Metallgestell und Glas

- Blanc - Weiss
- Chromé - Verchromt
- Nickel satiné - Nickel satiniert



ceiling lamp



E27 2x42W

2866-61-102 Bianco - White

2866-61-138 Cromo - Chrome

2866-61-178 Nichel satinato
Satined nickel

Turn&Lock

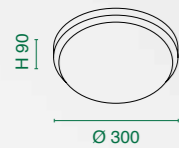
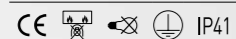

Ø 300

E27 3x42W

2866-66-102 Bianco - White

2866-66-138 Cromo - Chrome

2866-66-178 Nichel satinato
Satined nickel

Turn&Lock

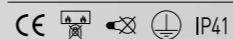

Ø 400

plaza LED

Design s.t. Fabas Luce

3566

Struttura in metallo e vetro in lastra - Metal frame and plate glass
 Monture en metal et verre plat - Metallgestell und Glas

- Blanc - Weiss
- Chromé - Verchromt
- Nickel satiné - Nickel satiniert



plaza 2866 - 3566

LED Warm white 3000K - 12W - 1100 lm

3566-61-102 Bianco - White

3566-61-138 Cromo - Chrome

3566-61-178 Nichel satinato
Satined nickel

Turn&Lock

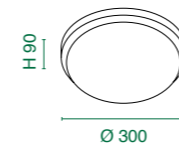
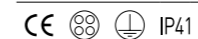

Ø 300

LED Warm white 3000K - 24W - 2400 lm

3566-65-102 Bianco - White

3566-65-138 Cromo - Chrome

3566-65-178 Nichel satinato
Satined nickel

Turn&Lock

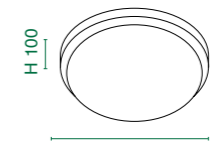

Ø 400

fox E27

Design s.t. Fabas Luce

2385

Struttura in metallo e vetro in lastra - Metal frame and plate glass
 Monture en metal et verre plat - Metallgestell und Glas

Blanc - Weiss 



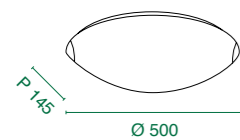

ceiling lamp



E27 3x40W

2385-64-102  Bianco - White

 Compatible - Compatible - Kompatibel
 [Pagina - Page - Seite 467]

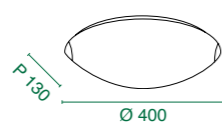

CE   IP20



E27 2x60W

2385-65-102  Bianco - White

 Compatible - Compatible - Kompatibel
 [Pagina - Page - Seite 467]

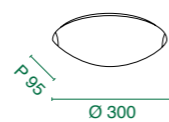

CE   IP20



E27 1x60W

2385-61-102  Bianco - White

 Compatible - Compatible - Kompatibel
 [Pagina - Page - Seite 467]

CE   IP20

fox LED

Design s.t. Fabas Luce

3564

Struttura in metallo e vetro in lastra - Metal frame and plate glass
 Monture en metal et verre plat - Metallgestell und Glas

Blanc - Weiss 



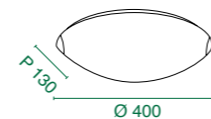

fox 2385 - 3564



LED Warm white 3000K - 24W - 2400 lm

3564-65-102  Bianco - White

CE   IP20

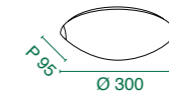

LED Warm white 3000K - 12W - 1100 lm

3564-61-102  Bianco - White

CE   IP20





ceiling lamp



E27 1x60W
2957-61-102 Bianco - White
Compatibile - Compatible - Kompatibel
[Pagina - Page - Seite 467]
CE IP20
L 300x300

E27 2x60W
2957-65-102 Bianco - White
Compatibile - Compatible - Kompatibel
[Pagina - Page - Seite 467]
CE IP20
L 400x400

E27 3x40W
2957-64-102 Bianco - White
Compatibile - Compatible - Kompatibel
[Pagina - Page - Seite 467]
CE IP20
L 460x460

E27 3x40W
2957-64-102 Bianco - White
Compatibile - Compatible - Kompatibel
[Pagina - Page - Seite 467]
CE IP20

2958

Struttura in metallo e vetro in lastra - Metal frame and plate glass
Monture en metal et verre plat - Metallgestell und Glas

Blanc - Weiss



ceiling lamp



E27 1x60W
2958-61-102 Bianco - White
Compatibile - Compatible - Kompatibel
[Pagina - Page - Seite 467]
CE

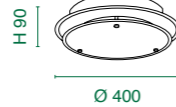

E27 2x60W
2958-65-102 Bianco - White
Compatibile - Compatible - Kompatibel
[Pagina - Page - Seite 467]
CE

3521

Struttura in metallo e vetro in lastra - Metal frame and plate glass
Monture en metal et verre plat - Metallgestell und Glas

Blanc - Weiss

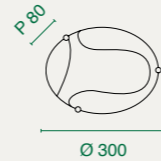

E27 1x40W
3521-61-102 Bianco - White
Compatibile - Compatible - Kompatibel
[Pagina - Page - Seite 467]
CE

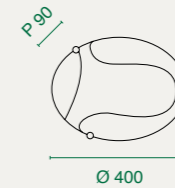

E27 2x40W
3521-65-102 Bianco - White
Compatibile - Compatible - Kompatibel
[Pagina - Page - Seite 467]
CE

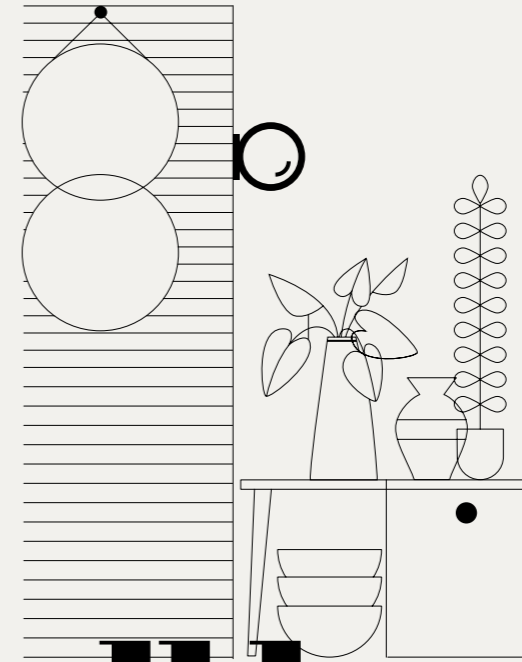

wall lamp

3682

Struttura in metallo, vetro e metacrilato - Metal, glass and methacrylate frame
 Monture en métal, verre et méthacrylate - Metall, Glas und Methacrylat



Ø wall lamp



Ambre - Amber   Gris transparent - Grau transparent
 Transparent 



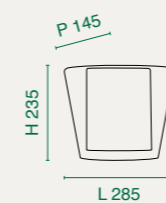

viki 3682





E27 1x40W

3682-21-125  Ambra - Amber

3682-21-126  Fumé - Transparent grey

3682-21-241  Trasparente - Transparent

CE    IP20

maribel

Design MBDO

3707

Struttura in metallo, vetro e metacrilato - Metal, glass and methacrylate frame
 Monture en métal, verre et méthacrylate - Metall, Glas und Methacrylat



Ø wall lamp



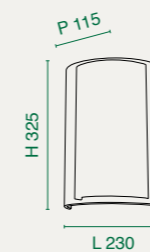

Ambre - Amber  Gris transparent - Grau transparent 
 Transparent 





E27 1x40W

3707-21-125  Ambra - Amber



3707-21-126  Fumé - Transparent grey

3707-21-241  Trasparente - Transparent

CE    IP20



Ø wall lamp

Ambre - Amber   Gris transparent - Grau transparent
 Transparent 



alide 3708

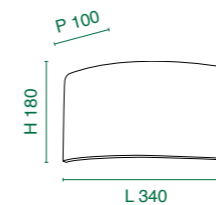



E27 1x40W

3708-21-125  Ambra - Amber

3708-21-126  Fumé - Transparent grey

3708-21-241  Trasparente - Transparent

CE   IP20

guia Design s.t. Fabas Luce
3799

Struttura in metallo e policarbonato - Metal and polycarbonate frame
Structure en métal et polycarbonate - Metall- und Polycarbonatstruktur

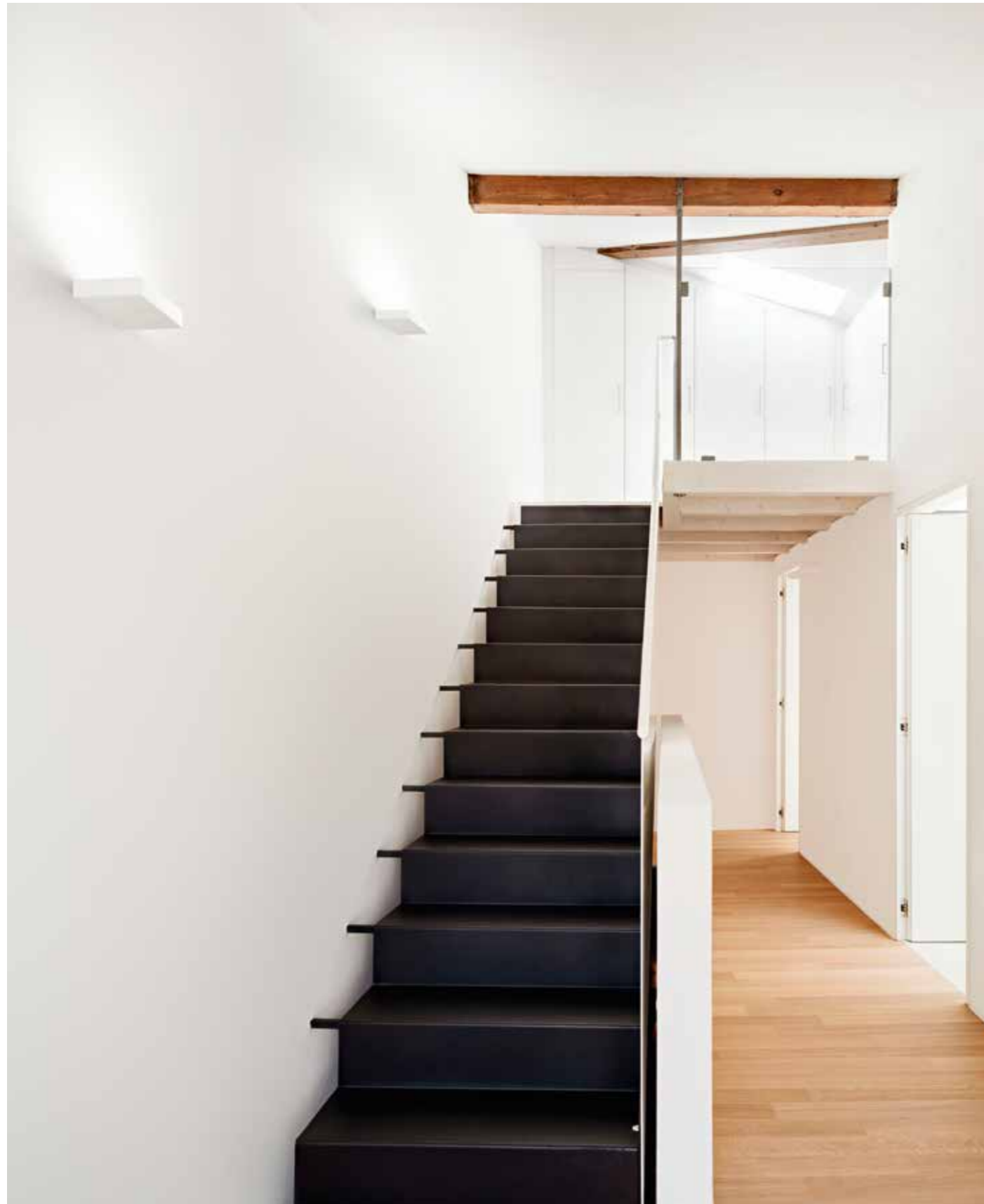

Ø wall lamp

Noir - Schwarz Blanc - Weiss



guia 3799

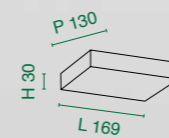

LED Warm white 3000K - 18W - 2546 lm

3799-21-101 Nero - Black

3799-21-102 Bianco - White

CE IP20



Noir - Schwarz   Blanc - Weiss



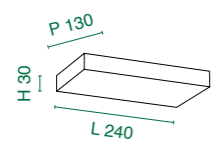

Ø wall lamp



LED Warm white 3000K - 24W - 2874 lm

3799-22-101  Nero - Black

3799-22-102  Bianco - White

CE   IP20



Noir - Schwarz   Blanc - Weiss



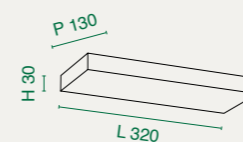

guia 3799



LED Warm white 3000K - 36W - 5092 lm

3799-26-101  Nero - Black

3799-26-102  Bianco - White

CE   IP20





3618

Struttura in metallo e metacrilato - Metal and methacrylate frame
 Monture en métal et méthacrylate - Metall und Methacrylat

Ø wall lamp



Blanc - Weiss  Laiton satiné - Messing satiniert 
 Anthracite - Anthrazit 



banny 3618

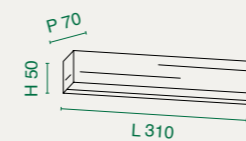

LED Warm white 3000K - 18W - 1700 lm

3618-21-102  Bianco - White



3618-21-119  Ottone satinato
 Satined brass

3618-21-282  Antracite - Anthracite

CE   IP20









Blanc - Weiss  Laiton satiné - Messing satiniert 
 Anthracite - Anthrazit 



LED Warm white 3000K - 24W - 2260 lm

- 3618-26-102**  Bianco - White
- 3618-26-119**  Ottone satinato Satined brass
- 3618-26-282**  Antracite - Anthracite

CE   IP20 

regolo

Design s.t. Fabas Luce

3558

Struttura in metallo e vetro in lastra - Metal frame and plate glass
Monture en métal et verre plat - Metallgestell und Glas



wall lamp

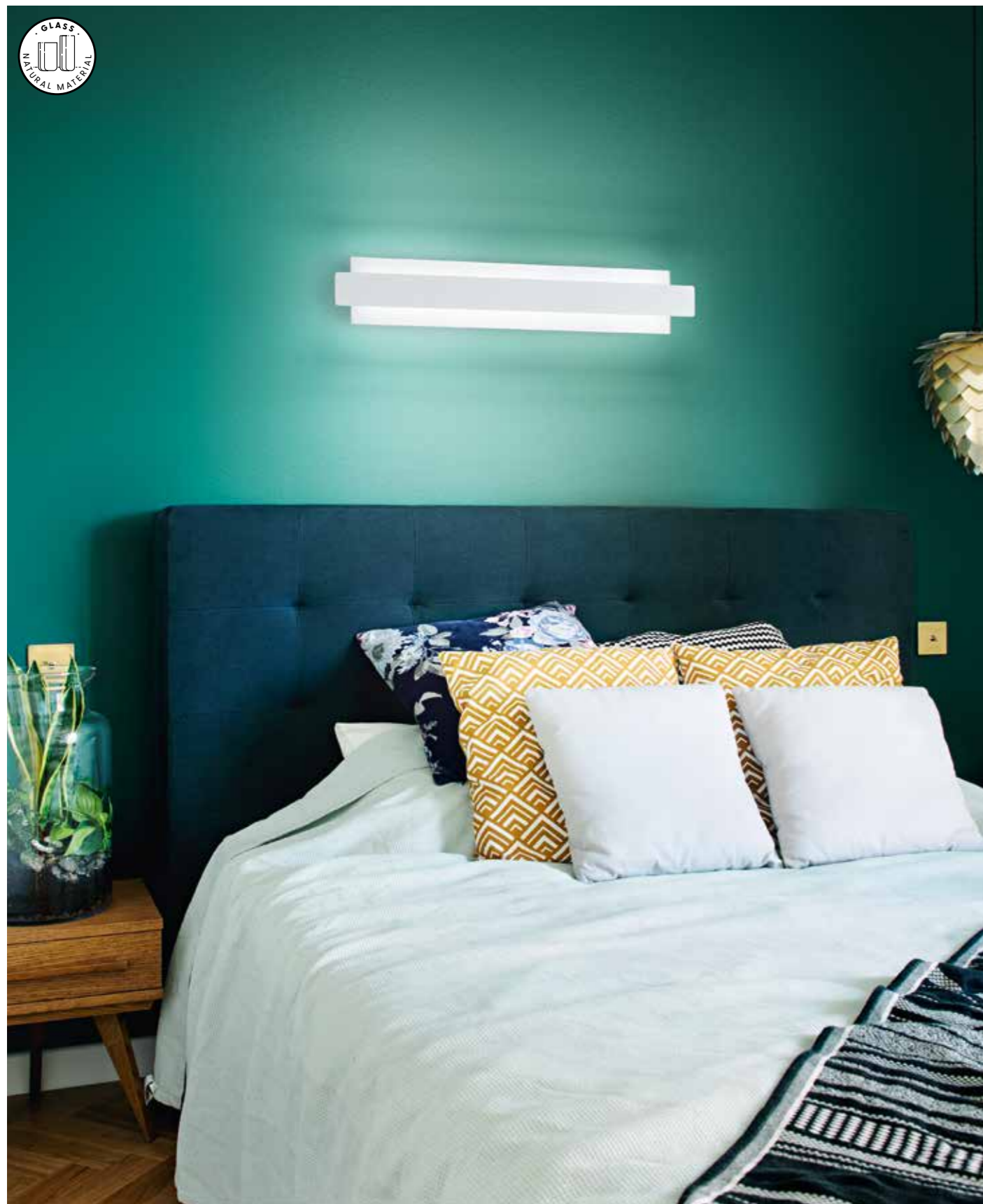

Noir - Schwarz Blanc - Weiss



regolo 3558

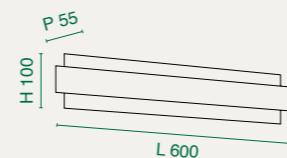

LED Warm white 3000K - 21W - 2150 lm

3558-22-101 Nero - Black

3558-22-102 Bianco - White

LED dimmerabile a taglio di fase
Phase cut dimmable LED
LED dimmable à découpage de phase
LED dimmbar (über Phasen- und abschnittsdimmer)

Compatibile - Compatible - Kompatibel
[Pagina - Page - Seite 467]

CE



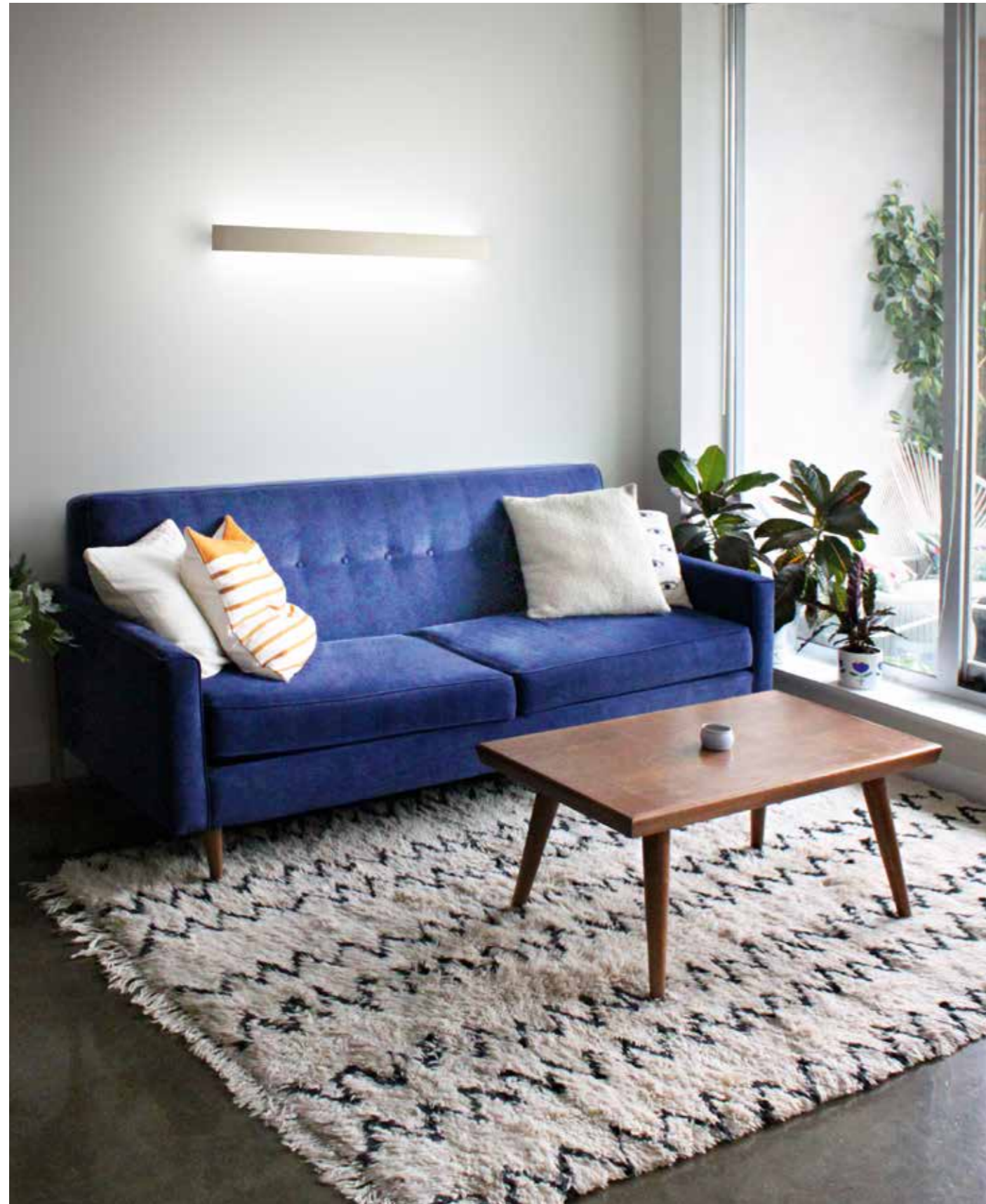

Blanc - Weiss Or mat - Gold edelmatt

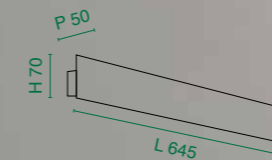

LED Warm white 3000K - 20W - 2700 lm

3559-22-102 Bianco - White

3559-22-225 Oro opaco - Gold matt

LED dimmerabile a taglio di fase
Phase cut dimmable LED
LED dimmable à découpage de phase
LED dimmbar (über Phasen- und abschnittdimmer)

Compatibile - Compatible - Kompatibel
[Pagina - Page - Seite 467]

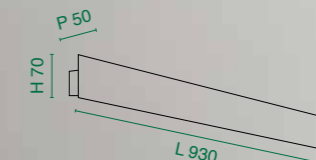
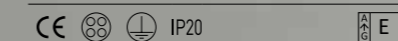

LED Warm white 3000K - 30W - 3900 lm

3559-26-102 Bianco - White

3559-26-225 Oro opaco - Gold matt

LED dimmerabile a taglio di fase
Phase cut dimmable LED
LED dimmable à découpage de phase
LED dimmbar (über Phasen- und abschnittdimmer)

Compatibile - Compatible - Kompatibel
[Pagina - Page - Seite 467]

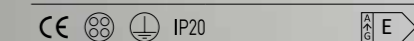

3394





Struttura in metallo e metacrilato - Metal and methacrylate frame
Monture en métal et méthacrylate - Metall und Methacrylat

collection:

page
94

page
216

page
376

Noir - Schwarz  Blanc - Weiss 
Or mat - Gold edelmatt  Corten - Rostbraun 
Anthracite - Anthrazit 

wall lamp



Montaggio a parete o soffitto
Wall or ceiling mounting
Montage au mur ou au plafond
Wand- oder Deckenmontage

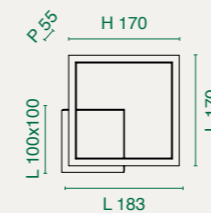

LED Warm white 3000K - 11W - 1080 lm

3394-24-101  Nero - Black

3394-24-102  Bianco - White

3394-24-225  Oro opaco - Gold matt

3394-24-282  Antracite - Anthracite

3394-24-361  Corten - Rostbraun

LED dimmerabile a taglio di fase
Phase cut dimmable LED
LED dimmable à découpage de phase
LED dimmbar (über Phasen- und abschnitt-dimmer)

CE   IP20

 E

- Noir - Schwarz  Blanc - Weiss 
- Or mat - Gold edelmatt  Corten - Rostbraun 
- Anthracite - Anthrazit 



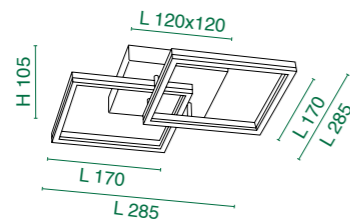

Ø wall lamp

Montaggio a parete o soffitto
Wall or ceiling mounting
Montage au mur ou au plafond
Wand- oder Deckenmontage



LED Warm white 3000K - 21W - 2160 lm

3394-28-101  Nero - Black



3394-28-102  Bianco - White

3394-28-225  Oro opaco - Gold matt

3394-28-282  Antracite - Anthracite

3394-28-361  Corten - Rostbraun

 LED dimmerabile a taglio di fase
Phase cut dimmable LED
LED dimmable à découpage de phase
LED dimmbar (über Phasen- und abschnittsdimmer)

CE   IP20

 E



bard 3394

Struttura in metallo e metacrilato - Metal and methacrylate frame
Monture en métal et méthacrylate - Metall und Methacrylat

collection:

page
88

page
224

■ Noir - Schwarz
□ Blanc - Weiss

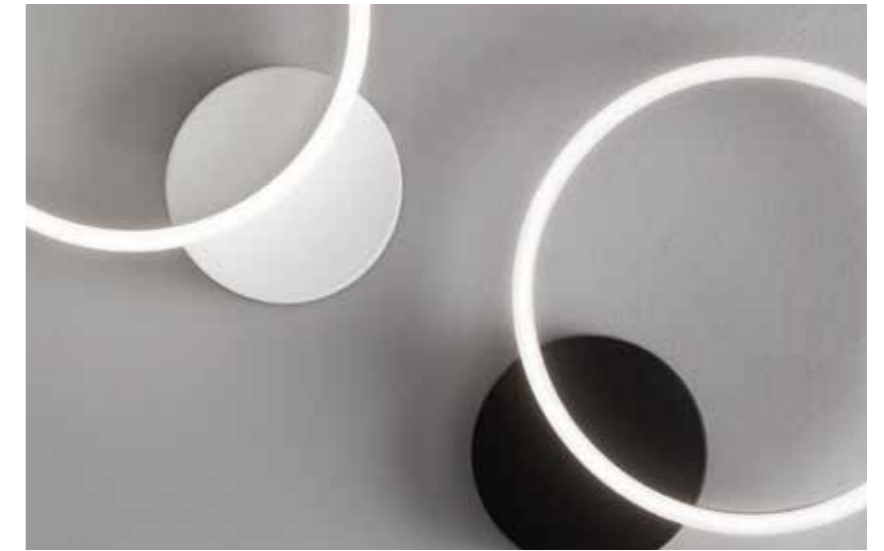

wall lamp

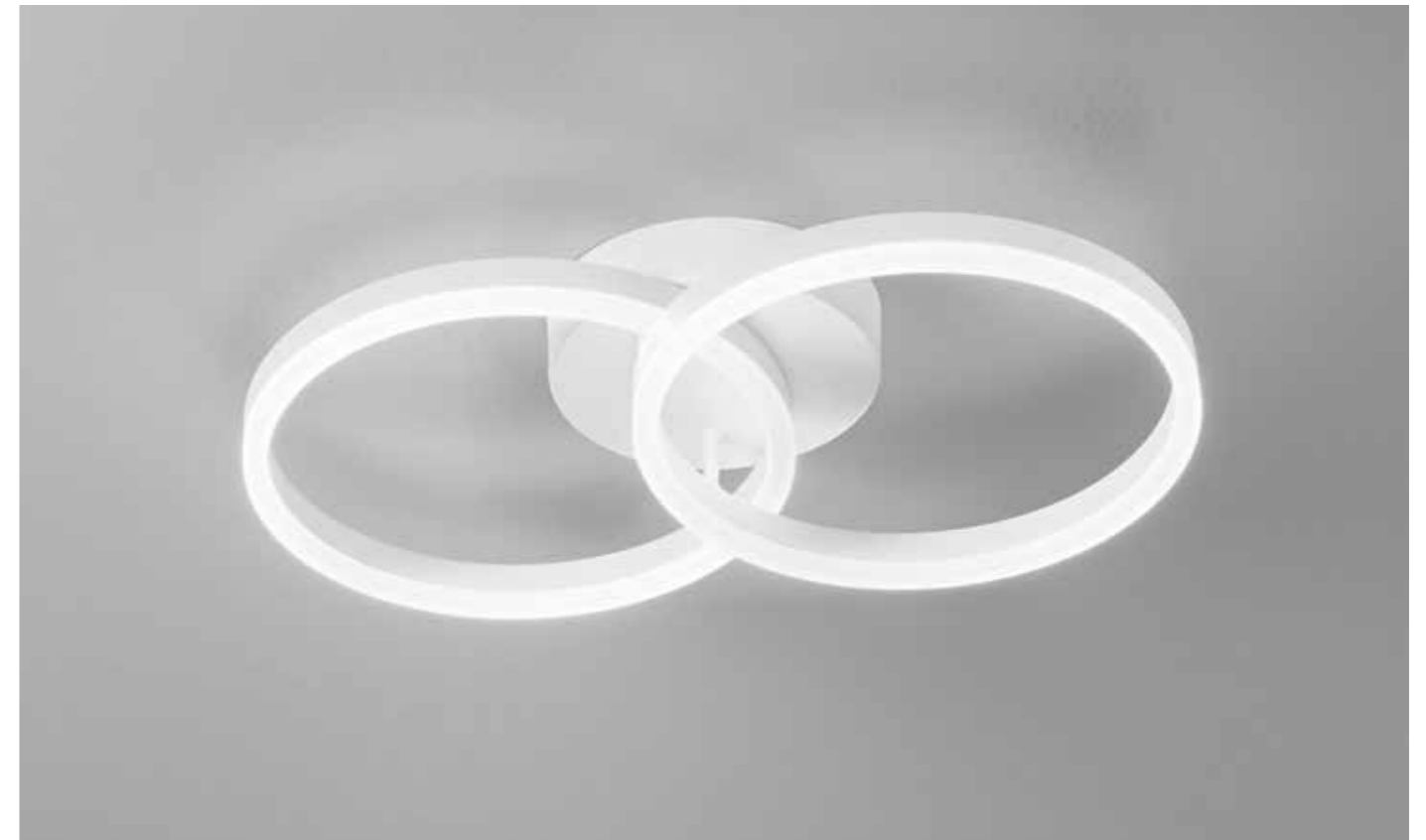
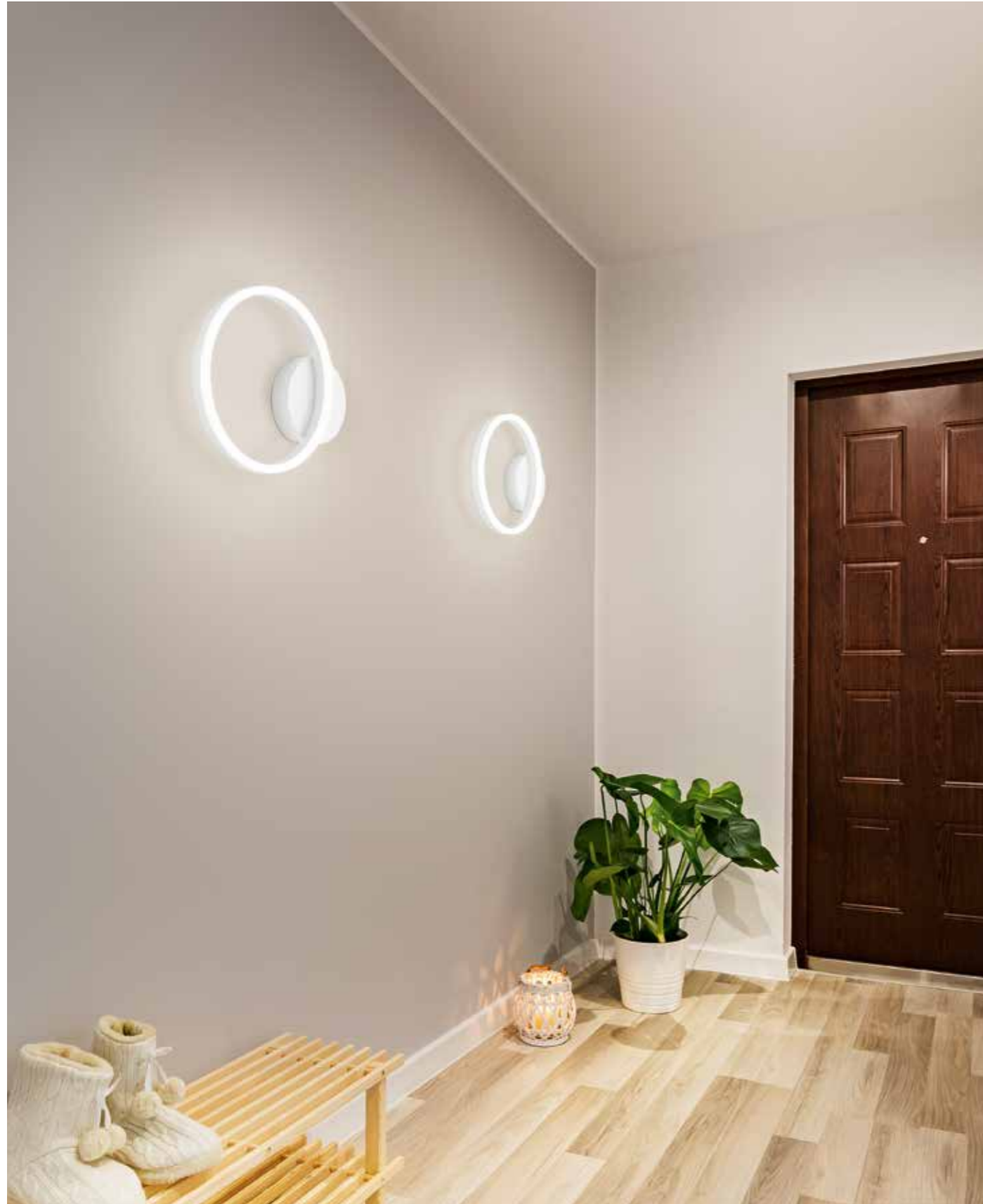

giotto 3508

Montaggio a parete o soffitto
Wall or ceiling mounting
Montage au mur ou au plafond
Wand- oder Deckenmontage

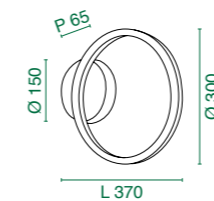

LED Warm white 3000K - 18W - 1890 lm

3508-21-101 ■ Nero - Black

3508-21-102 □ Bianco - White

LED dimmerabile a taglio di fase
Phase cut dimmable LED
LED dimmable à découpage de phase
LED dimmbar (über Phasen- und abschnittdimmer)

Integrato - Integrated - Intégré - Integriert
[Pagina - Page - Seite 467]

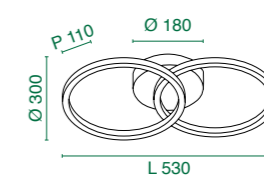
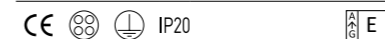

LED Warm white 3000K - 36W - 3780 lm

3508-22-101 ■ Nero - Black



3508-22-102 □ Bianco - White

LED dimmerabile a taglio di fase
Phase cut dimmable LED
LED dimmable à découpage de phase
LED dimmbar (über Phasen- und abschnittdimmer)

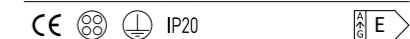
Integrato - Integrated - Intégré - Integriert
[Pagina - Page - Seite 467]







Noir - Schwarz  Blanc - Weiss 
Aluminium - Aluminium 



LED Warm white - Cold white 9W - 1135 lm

3551-21-101  Nero - Black

3551-21-102  Bianco - White

3551-21-212  Alluminio - Aluminium

Regolazione luce al tocco
Touch dimmer
Variateur sensitif
Touchdimmer

 Orientabile - Adjustable
Réglable - Schwenkbar

 3000K - 4000K - 5000K - 6000K

Dotata di cavo con interruttore e spina
Equipped with cable with switch and plug
Équipé d'un câble avec interrupteur et prise
Ausgestattet mit Kabel mit Schalter und Stecker

CE   IP20

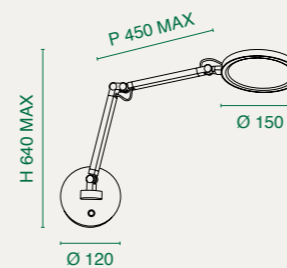

3253

Struttura in metallo e metacrilato - Metal and methacrylate frame
Monture en métal et méthacrylate - Metall - und Methacrylatgestell



Ø wall lamp



■ Nickel satiné - Nickel satiniert

mill 3253

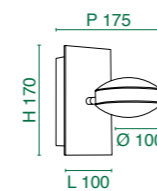

LED Warm white 3000K - 16W - 1510 lm

3253-21-178 ■ Nickel satinato - Satined nickel

⤴ Orientabile 360° - Adjustable 360°
Réglable 360° - Schwenkbar 360°

CE Ⓢ Ⓡ IP20

HA E

3506

Struttura in pressofusione di alluminio - Aluminum die-casting structure
 Structure de moulage en aluminium - Aluminiumdruckguss

Ø wall lamp



□ Blanc - Weiss



emma 3506

LED Warm white 3000K - 27W - 2250 lm

3506-21-955 □ Bianco - White

LED dimmerabile a taglio di fase
 Phase cut dimmable LED
 LED dimmable à découpage de phase
 LED dimmbar (über Phasen- und abschnitt-dimmer)

CE IP20

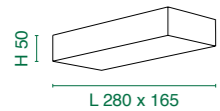

LED Warm white 3000K - 41W - 3750 lm

3506-22-955 □ Bianco - White

LED dimmerabile a taglio di fase
 Phase cut dimmable LED
 LED dimmable à découpage de phase
 LED dimmbar (über Phasen- und abschnitt-dimmer)

CE IP20

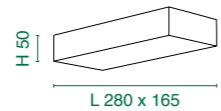

sunrise

Design Variaforma

3523

Struttura in pressofusione di alluminio - Aluminum die-casting structure
 Structure de moulage en aluminium - Aluminiumdruckguss



Ø wall lamp

Blanc - Weiss Or mat - Gold edelmatt



sunrise 3523

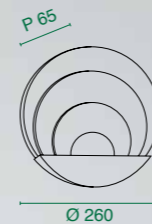

LED Warm white 3000K - 29W - 3240 lm

3523-21-102 Bianco - White

3523-21-225 Oro opaco - Gold matt

LED dimmerabile a taglio di fase
 Phase cut dimmable LED
 LED dimmable à découpage de phase
 LED dimmbar (über Phasen- und abschnitt-dimmer)

Compatibile - Compatible - Kompatibel
 [Pagina - Page - Seite 467]

CE IP20

E

3239

Struttura in metallo e metacrilato - Metal and methacrylate frame
 Monture en métal et méthacrylate - Metall und Methacrylat

collection: **page 80**

80



wall lamp



Laiton satiné - Messing satiniert   Aluminium brossé - Aluminium gebürstet



dunk 3239

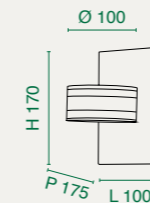



LED Warm white 3000K - 16W - 1510 lm

3239-21-119  Ottone satinato
 Satined brass

3239-21-212  Alluminio spazzolato
 Brushed aluminum

 Orientabile - Adjustable
 Réglable - Schwenkbar

 Compatibile - Compatible - Kompatibel
 [Pagina - Page - Seite 467]

CE   IP20



3690

Struttura in metallo e legno - Metal frame and wood
Monture en métal et en bois - Metall und Holz



Ø wall lamp



Bois de frêne - Eschenholz



loft 3690

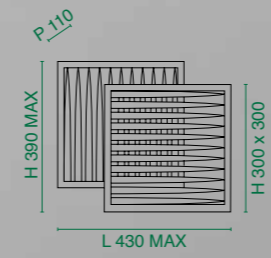

LED Warm white 3000K - 18W - 1980 lm

3690-21-132 Frassino - Ash wood

Orientabile - Adjustable
Réglable - Schwenkbar

CE IP20



3676

Struttura in metallo, legno e diffusore in metacrilato - Metal and wood frame and methacrylate diffuser
 Monture en métal et bois et diffuseur en méthacrylate - Metall- und Holzgestell mit Methacrylatabdeckung

Chêne - Eichenholz



wall lamp

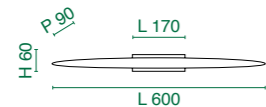

LED Warm white 3000K - 17W - 1400 lm
3676-21-215 Quercia - Oak
 LED dimmerabile a taglio di fase
 Phase cut dimmable LED
 LED dimmable à découpage de phase
 LED dimmbar (über Phasen-an- und abschnittdimmer)
 CE IP20

3672

Struttura in metallo e legno - Metal frame and wood
 Monture en métal et en bois - Metall und Holz

Bois de frêne - Eschenholz

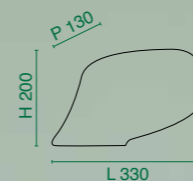

LED Warm white 3000K - 18W - 1980 lm
3672-21-132 Frassino - Ash wood
 LED dimmerabile a taglio di fase
 Phase cut dimmable LED
 LED dimmable à découpage de phase
 LED dimmbar (über Phasen-an- und abschnittdimmer)
 CE IP20

3663

Struttura in metallo e legno e vetro in lastra - Metal and wood frame and plate glass
Monture en metal et bois et verre plat - Metall und Holz mit Glas



Ø wall lamp

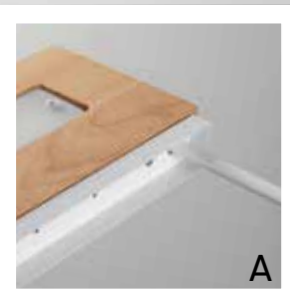

Nella confezione sono inclusi gli accessori per due diversi tipi di fissaggio:
A. Fissaggio tipo mensola adeguato a supportare oggetti fino a 5 kg.
B. Fissaggio standard per applique non adatto a supportare pesi.

The package includes accessories for two different types of fixing:
A. Shelf-type fixing suitable for supporting objects up to 5 kg.
B. Standard fixing for wall lights not suitable for supporting weight.

Dans l'emballage il est inclus des accessoires pour deux types de fixation différents:
A. Fixation de type étagères adaptée pour supporter un poids jusqu'à 5 kg.
B. Fixation standard ne convient pas pour supporter des poids.

In der Verpackung ist Zubehör für zwei verschiedene Befestigungsarten enthalten:
A. Regalbefestigung, geeignet für ein Traggewicht von bis zu 5 kg.
B. Standardbefestigung, Artikel nicht für Traggewichte geeignet.

linus 3663

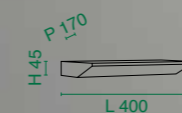

LED Warm white 3000K - 14W - 1380 lm
3663-21-215  Quercia - Oak

LED dimmerabile a taglio di fase
Phase cut dimmable LED
LED dimmable à découpage de phase
LED dimmbar (über Phasen-an- und abschnitt-dimmer)

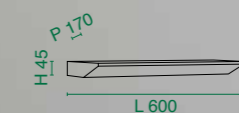
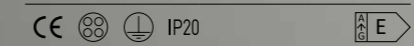

LED Warm white 3000K - 27W - 2770 lm
3663-26-215  Quercia - Oak

LED dimmerabile a taglio di fase
Phase cut dimmable LED
LED dimmable à découpage de phase
LED dimmbar (über Phasen-an- und abschnitt-dimmer)



cordoba

Blank Design Studio

3697

Struttura in metallo e legno - Metal frame and wood
 Monture en métal et en bois - Metallrahmen und Holz

collection:

page
152

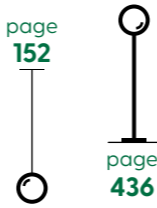

page
436

Blanc - Weiss



wall lamp

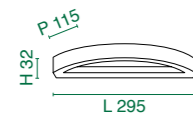

LED Warm white 3000K - 12W - 1300 lm

3697-21-102 Bianco - White



badia

Design Variaforma

3383

Struttura in metallo e legno - Metal frame and wood
 Monture en métal et en bois - Metallrahmen und Holz

collection:

page
158



Chêne - Eichenholz

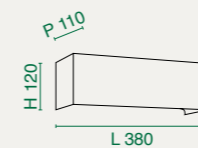

LED Warm white 3000K - 16W - 1940 lm

3383-21-215 Quercia - Oak

Compatibile - Compatible - Kompatibel
 [Pagina - Page - Seite 467]

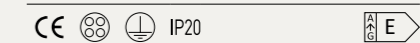

window

Design MBDO

3471

Struttura in metallo, legno e diffusore in metacrilato - Metal and wood frame and methacrylate diffuser
 Monture en metal et bois et diffuseur en méthacrylate - Metall- und Holzgestell mit Methacrylatabdeckung



wall lamp



Chêne - Eichenholz



window 3471

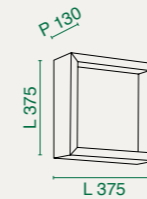

LED Warm white 3000K - 29W - 2880 lm
3471-22-215 ■ Quercia - Oak
 Dotata di cavo con interruttore e spina
 Equipped with cable with switch and plug
 Equipé d'un câble avec interrupteur et prise
 Ausgettatet mit Kabel mit Schalter und Stecker
 CE IP20 E

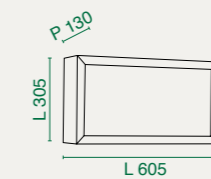

LED Warm white 3000K - 35W - 3450 lm
3471-26-215 ■ Quercia - Oak
 Dotata di cavo con interruttore e spina
 Equipped with cable with switch and plug
 Equipé d'un câble avec interrupteur et prise
 Ausgettatet mit Kabel mit Schalter und Stecker
 CE IP20 E

dedalo

Design s.t. Fabas Luce

2523

Struttura in metallo e vetro soffiato - Metal frame and blown glass
 Monture en metal et verre soufflé - Metallgestell und geblasenes Glas

Blanc - Weiss



wall lamp

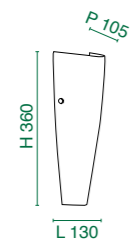

E27 1x75W

2523-21-102 Bianco - White

CE IP20

domizia

Design Studio Leggero

3689

Struttura in metallo e vetro soffiato - Metal frame and blown glass
 Monture en metal et verre soufflé - Metallgestell und geblasenes Glas

Noir - Schwarz

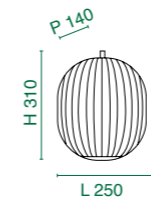

E27 1x40W

3689-21-101 Nero - Black

CE IP20

collection:

page 140



page 352

page 440



pandora E27

Design s.t. Fabas Luce

2433

collection: page
234

Struttura in metallo e vetro soffiato - Metal frame and blown glass
Monture en metal et verre soufflé - Metallgestell und geblasenes Glas

Blanc - Weiss



wall lamp

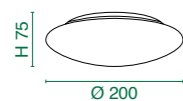

E27 1x40W
2433-23-102 Bianco - White
© Turn&lock
CE IP20

maggie

Design s.t. Fabas Luce

2957

collection: page
244

Struttura in metallo e vetro in lastra - Metal frame and plate glass
Monture en metal et verre plat - Metallgestell und Glas

Blanc - Weiss

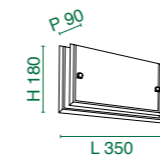

E27 1x60W
2957-21-102 Bianco - White
CE IP20

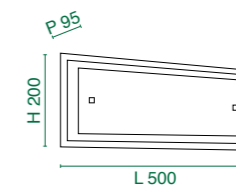

E27 2x60W
2957-26-102 Bianco - White
CE IP20

2958

Struttura in metallo e vetro in lastra - Metal frame and plate glass
Monture en metal et verre plat - Metallgestell und Glas

Blanc - Weiss



wall lamp

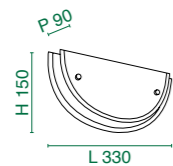

E27 1x60W
2958-21-102 Bianco - White
CE IP20

3113

Struttura in metallo e vetro in lastra - Metal frame and plate glass
Monture en metal et verre plat - Metallgestell und Glas

Blanc - Weiss



E27 1x60W
3113-22-102 Bianco - White
CE IP20

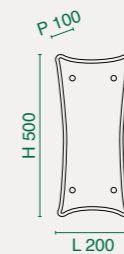

E27 2x60W
3113-26-102 Bianco - White
CE IP20



3177

Struttura in metallo e vetro in lastra - Metal frame and plate glass
 Monture en metal et verre plat - Metallgestell und Glas

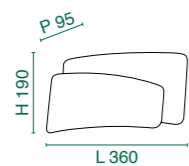

Ø wall lamp



E27 1x60W
3177-21-178  Nichel satinato - Satined nickel
 CE   IP20

3249

Struttura in metallo e vetro curvato - Metal frame and curved glass
 Monture en metal et verre courbé - Metallgestell und gebogenes Glas

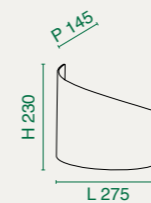

E27 1x75W
3249-21-102  Bianco - White
 CE   IP20

3414

Struttura in metallo e vetro soffiato - Metal frame and blown glass
 Monture en métal et verre soufflé - Metallgestell und geblasenes Glas

collection:



page
378

Bianc - Weiss

Argent - Silber

Or mat - Gold edelmatt



Ø wall lamp

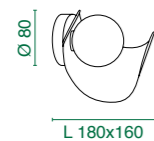

LED Warm white 3000K - 6W - 540 lm

3414-21-102 Bianco - White

3414-21-137 Argento - Silver

3414-21-225 Oro opaco - Gold matt

Orientabile - Adjustable
 Réglable - Schwenkbar

CE



2899

Struttura in metallo e vetro soffiato - Metal frame and blown glass
 Monture en metal et verre soufflé - Metallgestell und geblasenes Glas

Rouille foncé - Dunkel rostfarbig

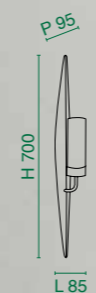

E14 1x60W

2899-26-171 Ruggine scuro - Dark rust

CE

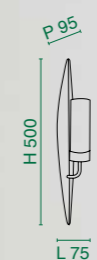

E14 1x60W

2899-21-171 Ruggine scuro - Dark rust

CE

3521

Struttura in metallo e vetro in lastra - Metal frame and plate glass
Monture en metal et verre plat - Metallgestell und Glas

Blanc - Weiss

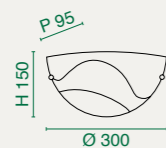

E27 1x40W
3521-21-102 Bianco - White
CE

Ø wall lamp

2385

Struttura in metallo e vetro in lastra - Metal frame and plate glass
Monture en metal et verre plat - Metallgestell und Glas

Blanc - Weiss

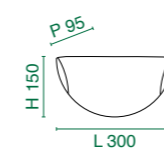

E27 1x60W
2385-21-102 Bianco - White
CE



wall lamp



LED Warm white 3000K - 9,5W - 960 lm

3715-20-101  Nero - Black

Regolazione luce al tocco
Touch dimmer
Variateur sensitif
Touchdimmer

 Orientabile - Adjustable
Réglable - Schwenkbar

   IP20





Ø wall lamp

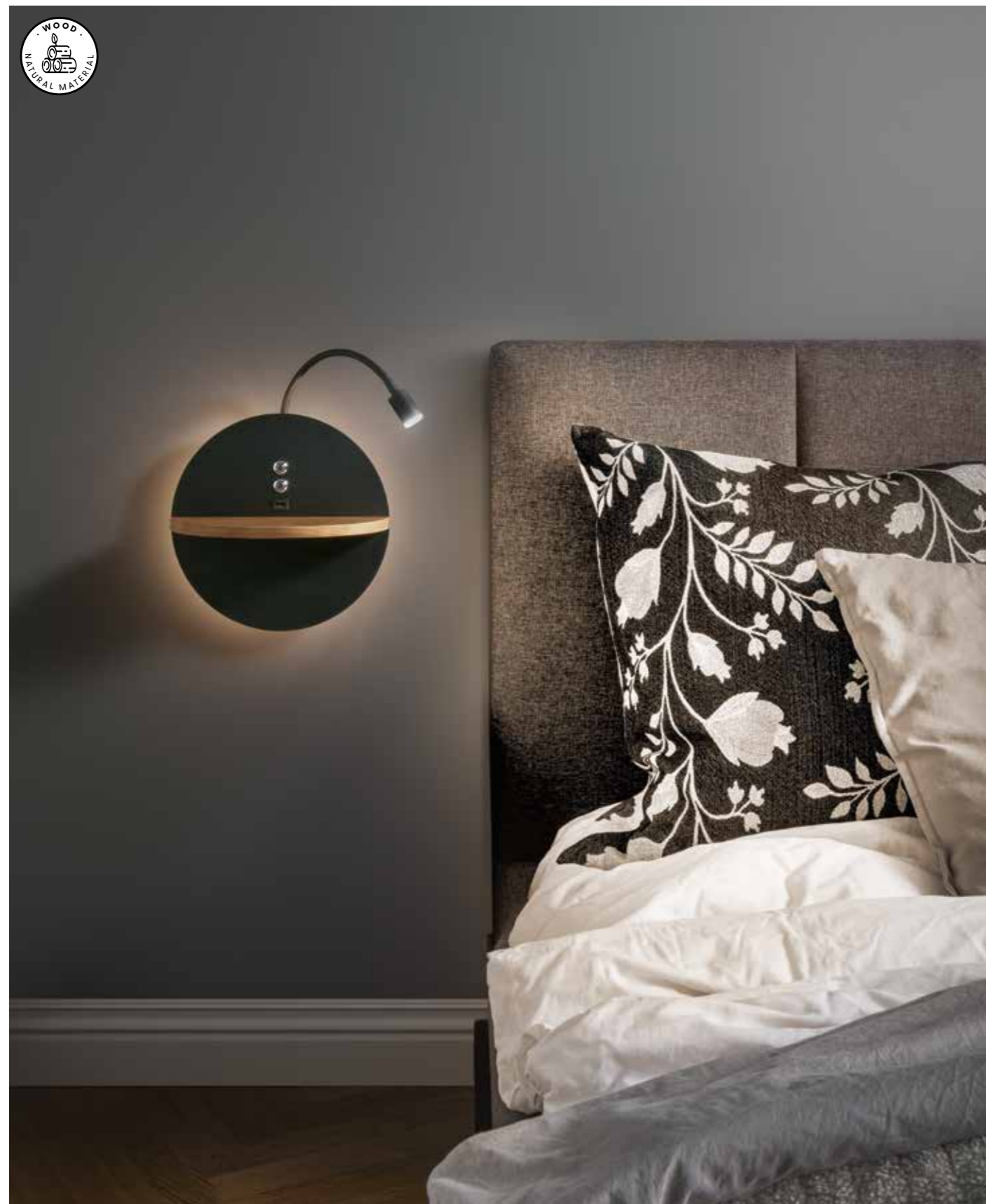

Noir - Schwarz Blanc - Weiss



dual 3717



LED Warm white 3000K - 9W + 6,5W - 750 lm + 630 lm

3717-20-101 Nero - Black

3717-20-102 Bianco - White

Regolazione luce al tocco
Touch dimmer
Variateur sensitif
Touchdimmer

Orientabile - Adjustable
Réglable - Schwenkbar

USB charger

Con retroilluminazione
With backlight
Avec rétroéclairage
Mit Rückbeleuchtung

CE IP20



goodnight

Design MBDO

3417

Struttura in metallo e vetro soffiato - Metal frame and blown glass
 Monture en metal et verre soufflé - Metallgestell und geblasenes Glas



wall lamp



- Anthracite - Anthrazit
- Gris souris/Beige - Graubraun/Beige



goodnight 3417



LED Warm white 3000K - 8W - 720 lm

3417-20-164 Antracite - Anthracite

3417-20-292 Tortora/Beige
 Dove grey/Beige

Regolazione luce con pulsante
 Push dimmer
 Bouton poussoir dimmable
 Tastdimmer

USB charger



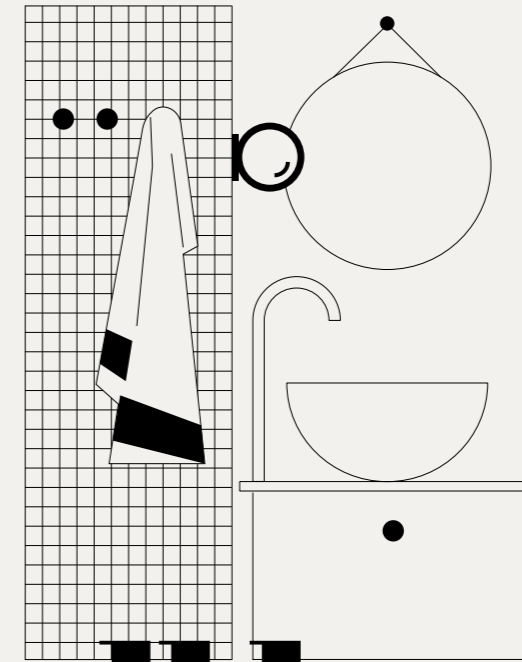

wall lamp
IP44

3361

Struttura in metallo e metacrilato - Metal and methacrylate frame
 Monture en métal et méthacrylate - Metall - und Methacrylatgestell

Ø wall lamp

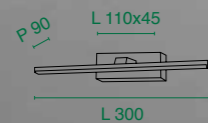

LED Warm white 3000K - 6W - 700 lm

3361-21-101 ■ Nero - Black

3361-21-102 □ Bianco - White

3361-21-138 □ Cromo - Chrome

CE IP44

Noir - Schwarz ■ Blanc - Weiss □
 Chromé - Verchromt □

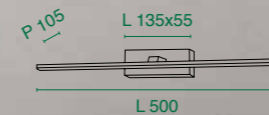

LED Warm white 3000K - 10W - 1200 lm

3361-26-101 ■ Nero - Black

3361-26-102 □ Bianco - White

3361-26-138 □ Cromo - Chrome

CE IP44

nala 3361



Noir - Schwarz Blanc - Weiss
 Chromé - Verchromt

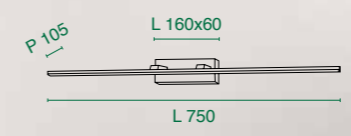

LED Warm white 3000K - 15W - 1850 lm
3361-28-101 Nero - Black
3361-28-102 Bianco - White
3361-28-138 Cromo - Chrome
 CE IP44

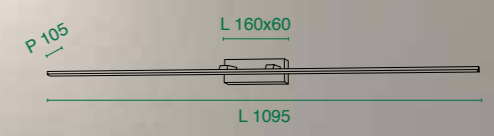

LED Warm white 3000K - 20W - 2460 lm
3361-29-101 Nero - Black
3361-29-102 Bianco - White
3361-29-138 Cromo - Chrome
 CE IP44

rapallo

Design s.t. Fabas Luce

3552

Struttura in metallo e metacrilato - Metal and methacrylate frame
 Monture en métal et méthacrylate - Metall - und Methacrylatgestell



Ø wall lamp

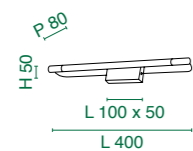

LED Warm white 3000K - 10W - 1150 lm

- 3552-21-119** ■ Ottone satinato / Satined brass
- 3552-21-138** ■ Cromo - Chrome

CE IP44

Chromé - Verchromt ■ ■ Laiton satiné - Messing satiniert



rapallo 3552

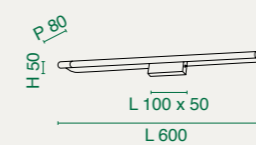

LED Warm white 3000K - 14W - 1580 lm

- 3552-26-119** ■ Ottone satinato / Satined brass
- 3552-26-138** ■ Cromo - Chrome

CE IP44

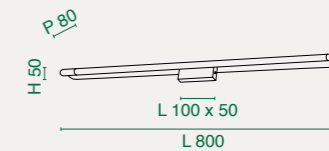

LED Warm white 3000K - 20W - 2240 lm

- 3552-28-119** ■ Ottone satinato / Satined brass
- 3552-28-138** ■ Cromo - Chrome

CE IP44

iglesias

Design s.t. Fabas Luce

3431

Chromé - Verchromt 

Struttura in metallo e metacrilato - Metal and methacrylate frame
 Monture en métal et méthacrylate - Metall - und Methacrylatgestell

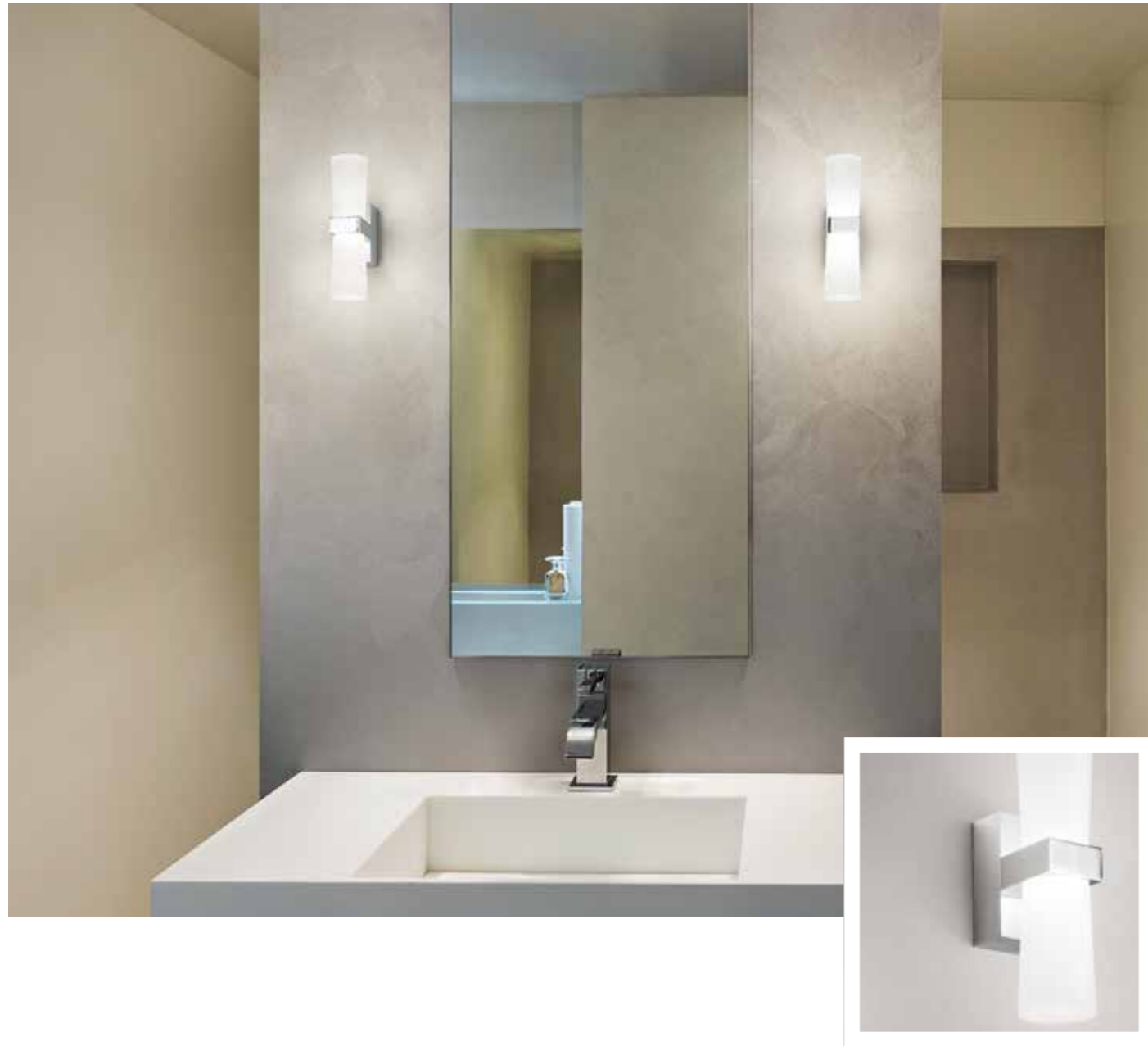

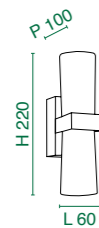

wall lamp



LED Warm white 3000K - 8W - 720 lm

3431-26-138  Cromo - Chrome

CE   IP44 

dedalo

Design s.t. Fabas Luce

2642

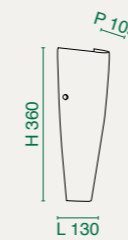

Blanc - Weiss 

Struttura in metallo e vetro soffiato - Metal frame and blown glass
 Monture en metal et verre soufflé - Metallgestell und geblasenes Glas



E27 1x60W

2642-21-102  Bianco - White

CE   IP44

Struttura in metallo e metacrilato - Metal and methacrylate frame
Monture en métal et méthacrylate - Metall - und Methacrylatgestell



Ø wall lamp

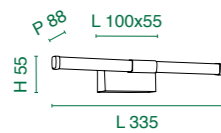

LED Warm white 3000K - 8W - 480 lm

3720-21-101 ■ Nero - Black

3720-21-138 ■ Cromo - Chrome

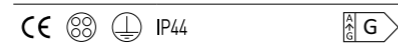

Noir - Schwarz ■ Chromé - Verchromt



ago 3720

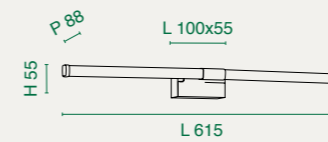

LED Warm white 3000K - 14W - 840 lm

3720-26-101 ■ Nero - Black

3720-26-138 ■ Cromo - Chrome

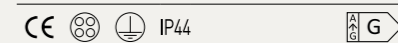

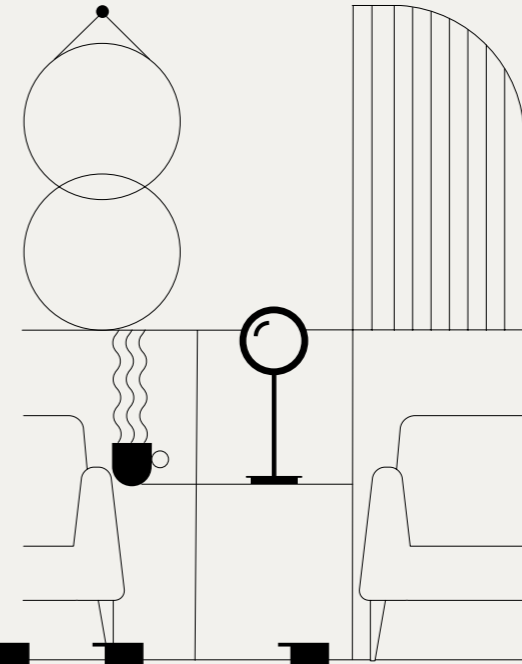

table lamp

3792

Struttura in metallo e vetro borosilicato - Metal frame and borosilicate glass
Monture en métal et verre borosilicaté - Metall und Borsilicatglas



HO table lamp



Amethyste - Amethyst Gris transparent - Grau transparent
Or - Gold Transparent



flick 3792

Amethyste - Amethyst   Gris transparent - Grau transparent
 Or - Gold   Transparent

table lamp

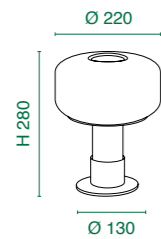

E14 Max 15W



3792-30-107  Ametista - Amethyst

3792-30-126  Fumé - Transparent grey

3792-30-189  Oro - Gold

3792-30-241  Trasparente - Transparent

Regolazione luce al tocco
 Touch dimmer
 Variateur sensitif
 Touchdimmer



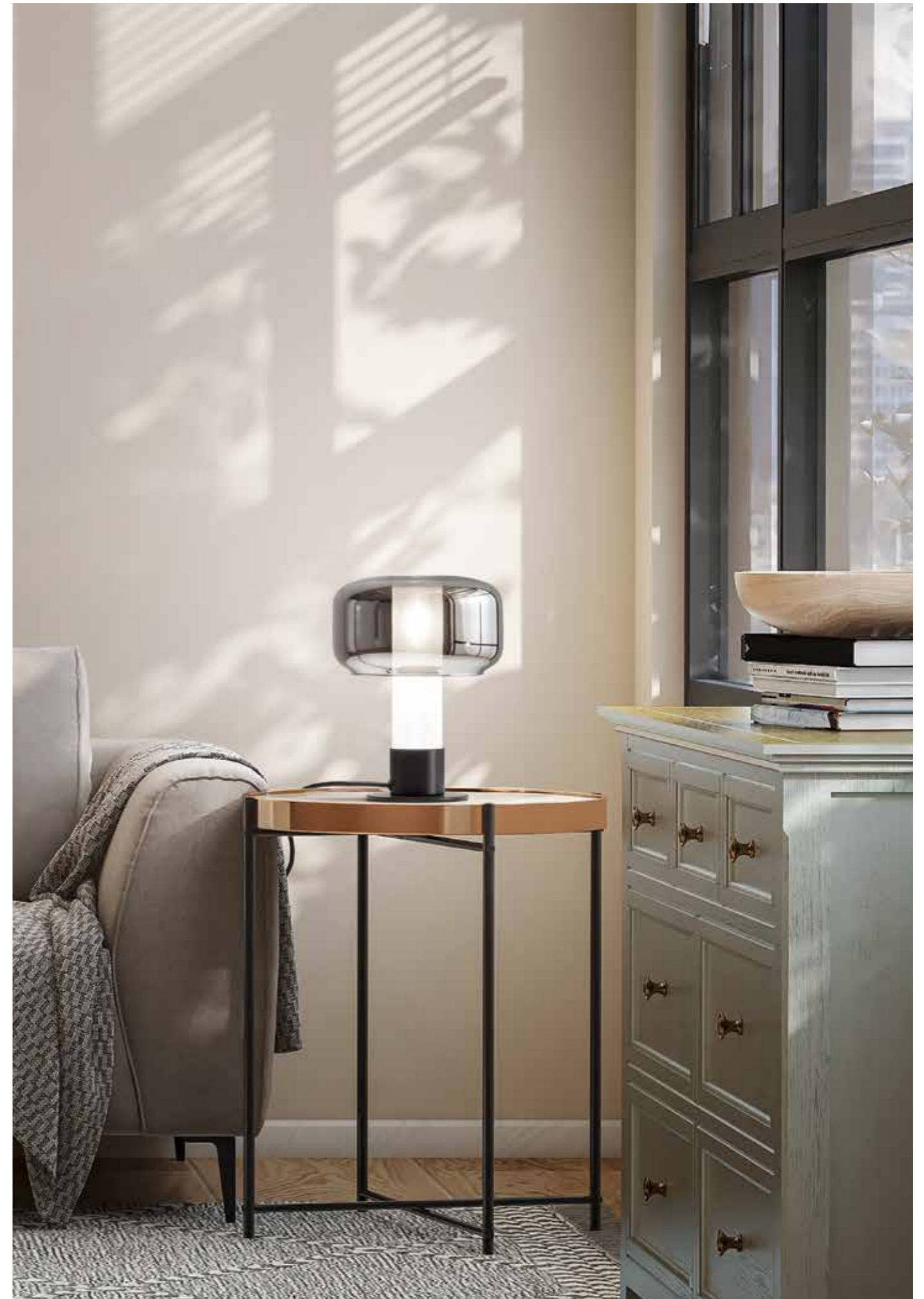

CE   IP20

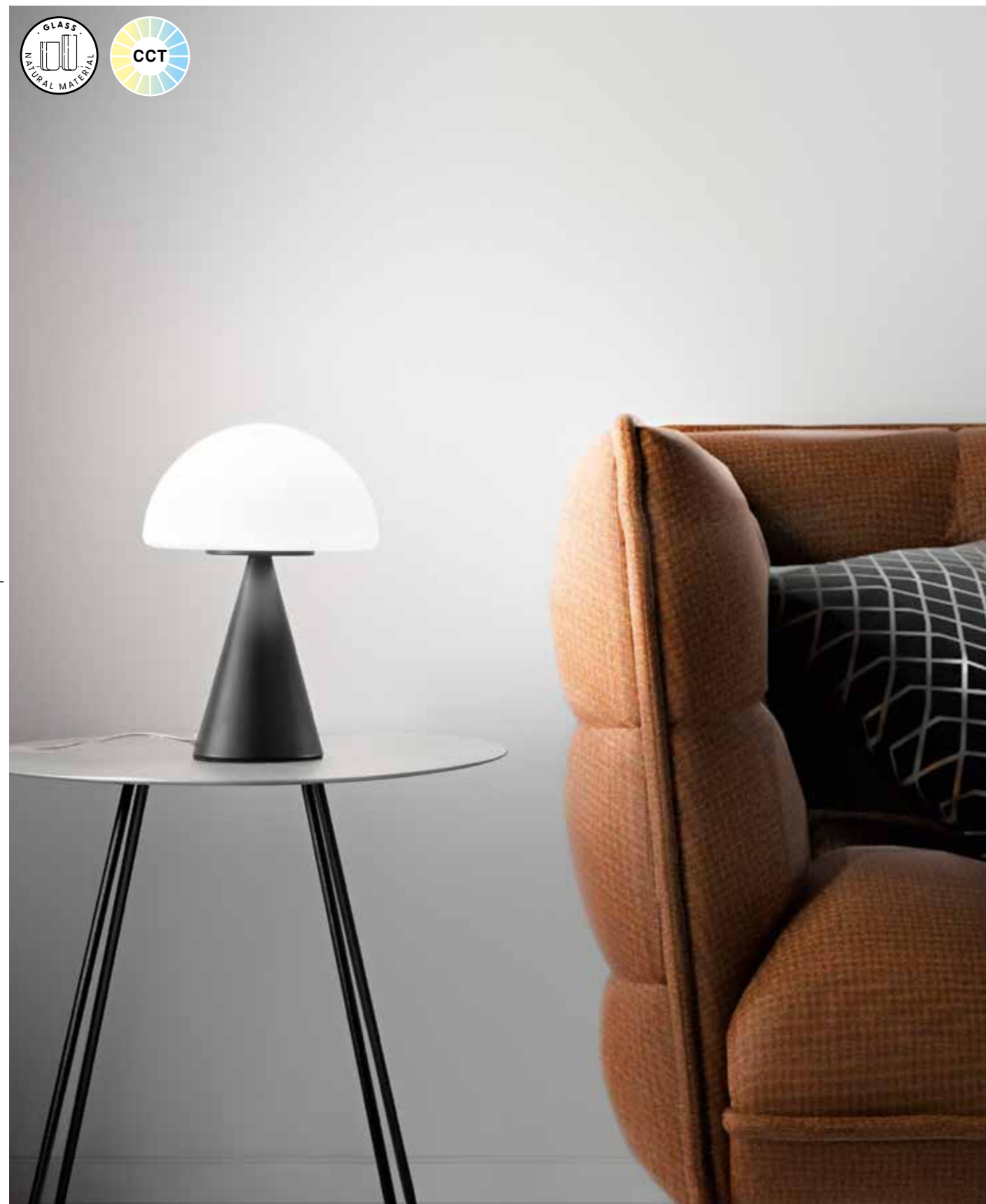

flick 3792





Noir - Schwarz  Blanc - Weiss 
 Rouge brique - Ziegelrot  Laiton satiné - Messing satiniert 
 Sable - Sandfarbe 



Modalità semplice per selezionare la temperatura colore.
 Simple way to select the color temperature.
 Un moyen simple de sélectionner la température de couleur.
 Einfache Möglichkeit, die Farbtemperatur auszuwählen.



LED Warm white - Natural white 7W - 500 lm

3790-30-101  Nero - Black

3790-30-102  Bianco - White

3790-30-119  Ottone satinato - Satined brass

3790-30-355  Sabbia - Sand

3790-30-375  Rosso Mattone - Brick red

 Regolazione luce al tocco
 Touch dimmer
 Variateur sensitif
 Touchdimmer

 2700K - 3000K - 4000K

CE   IP20

 E



table lamp



Blanc/Laiton satiné - Weiß/Messing satiniert Blanc/Chromé - Weiß/Verchromt
Vert/Laiton satiné - Grün/Messing satiniert Orange/Laiton satiné - Orange/Messing satiniert



wilma 3763



LED Warm white 3000K - 8W - 780 lm

- 3763-30-102** Bianco/Ottone satinato
White/Satinized brass
- 3763-30-138** Bianco/Cromato
White/Chromed
- 3763-30-155** Verde/Ottone satinato
Green/Satinized brass
- 3763-30-170** Arancio/Ottone satinato
Orange/Satinized brass

Regolazione luce al tocco
Touch dimmer
Variateur sensitif
Touchdimmer

CE IP20





table lamp



Blanc/Laiton satiné - Weiß/Messing satiniert   Rouge/Laiton satiné - Rot/Messing satiniert
 Blanc/Chromé - Weiß/Verchrom   Vert/Laiton satiné - Grün/Messing satiniert



wendy 3762

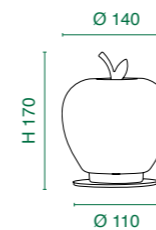

LED Warm white 3000K - 8W - 780 lm



3762-30-102  Bianco/Ottone satinato
White/Satined brass

3762-30-104  Rosso/Ottone satinato
Red/Satined brass

3762-30-138  Bianco/Cromato
White/Chromed

3762-30-155  Verde/Ottone satinato
Green/Satined brass

Regolazione luce al tocco
 Touch dimmer
 Variateur sensitif
 Touchdimmer

CE   IP20

 E

3752

Vetro soffiato - Blown glass
Verre soufflé - Geblasenes Glas



table lamp



Noir - Schwarz  Blanc - Weiss 
Rouge - Rot  Ambre - Amber 



freddy 3752





E27 1x40W

3752-30-101  Nero - Black

3752-30-102  Bianco - White

3752-30-104  Rosso - Red

3752-30-125  Ambra - Amber

 Con interruttore
With switch
Avec interrupteur
Mit Schalter



   IP20



table lamp



Transparent goutte - Transparent Tropfen



ariel 3770



LED Warm white - Natural white 11W - 1080 lm

3770-30-372 Trasparente/Goccia
 Transparent/Drop

Regolazione luce al tocco
 Touch dimmer
 Variateur sensitif
 Touchdimmer

2700K - 3000K - 4000K

CE IP20

E

3755

Struttura in metallo e vetro borosilicato - Metal frame and borosilicate glass
 Monture en métal et verre borosilicaté - Metall und Borsilicatglas

collection: page 30 page 202

Transparent Cognac

table lamp



brena 3755

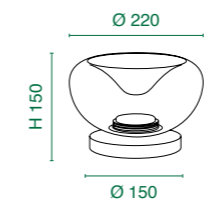
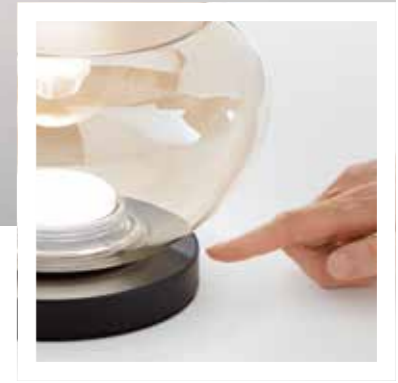

LED Warm white - Natural white 5,5W - 540 lm

3755-30-241 Traspirente - Transparent

3755-30-365 Cognac

Regolazione luce al tocco
 Touch dimmer
 Variateur sensitif
 Touchdimmer

2700K - 3000K - 4000K

CE IP20

3754

Struttura in metallo, legno e vetro soffiato - Metal frame, wood, blown glass
 Monture en métal, bois et verre soufflé - Metall, Holz und geblasenes Glas



table lamp

Noir - Schwarz ■ Chêne - Eichenholz
 Jaune/rouge/noir - Gelb/Rot/Schwarz ■

G9 1x20W

3754-30-101 ■ Nero - Black

3754-30-215 ■ Quercia - Oak

3754-30-366 ■ Giallo/rosso/nero
 Yellow/red/black

Regolazione luce al tocco
 Touch dimmer
 Variateur sensitif
 Touchdimmer

Lampadina G9 LED 3W dimmerabile inclusa
 Bulb G9 LED 3W dimmable included
 Ampoule G9 LED 3W dimmable incluse
 G9 LED 3W dimmbares LM inklusive

CE IP20

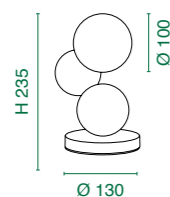

micky 3754

Struttura in metallo, legno e vetro soffiato - Metal frame, wood, blown glass
 Monture en métal, bois et verre soufflé - Metall, Holz und geblasenes Glas



table lamp

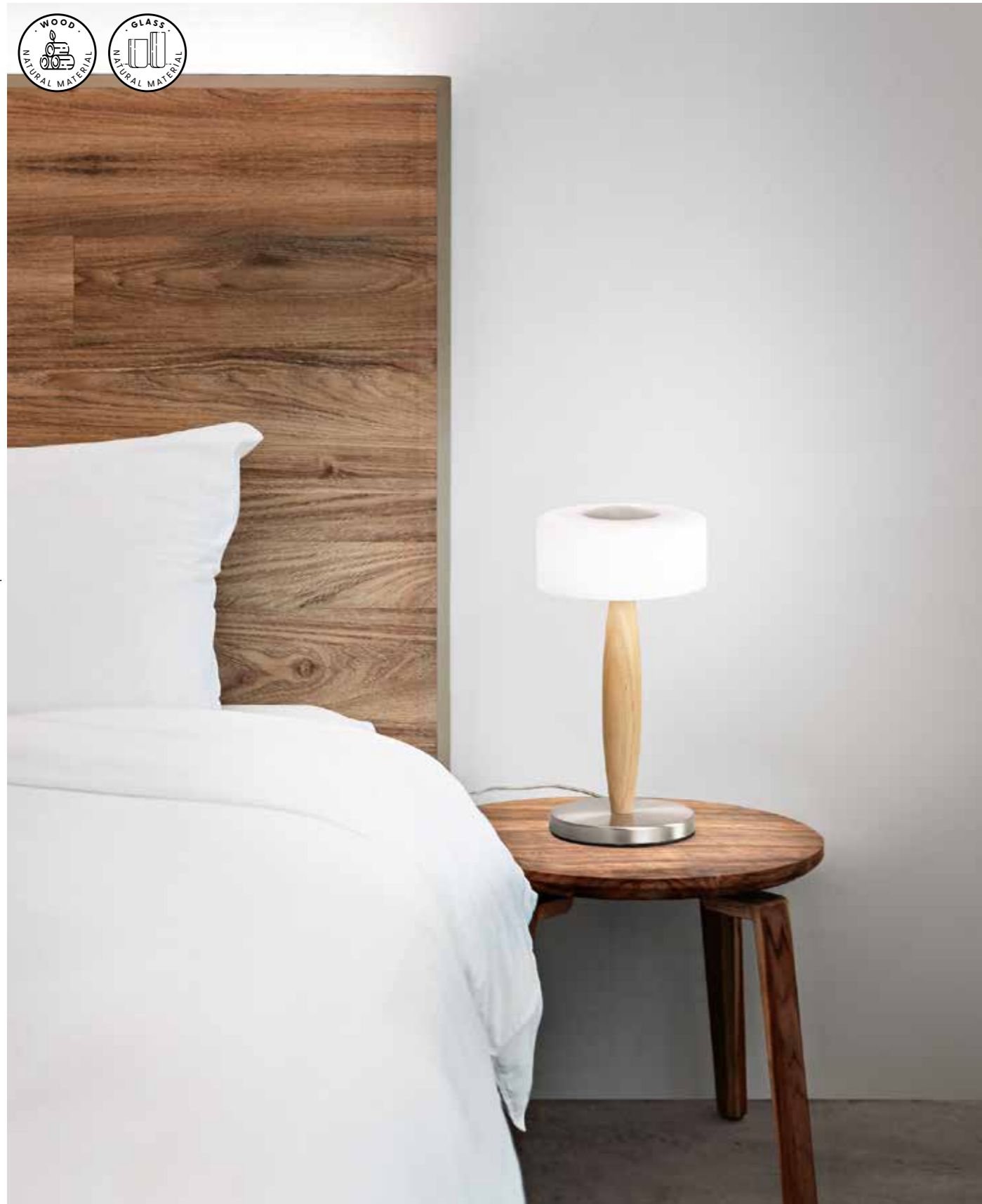

Noir - Schwarz ■ Laiton satiné - Messing satiniert
 Nickel satiné - Nickel satiniert ■



elea 3761

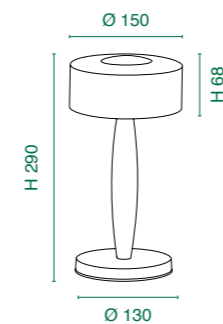

LED Warm white 3000K - 8W - 860 lm

3761-30-101 ■ Nero - Black

3761-30-119 ■ Ottone satinato - Satined brass

3761-30-178 ■ Nichel satinato - Satined nickel

Regolazione luce al tocco
 Touch dimmer
 Variateur sensitif
 Touchdimmer

CE IP20

E





3703

Struttura in metallo e vetro soffiato - Metal frame and blown glass
 Monture en métal et verre soufflé - Metall und geblasenes Glas



table lamp



Noir - Schwarz  Blanc - Weiss 
 Laiton satiné - Messing satiniert  Nickel satiné - Nickel satiniert 



ibla 3703



LED Warm white 3000K - 9W - 750 lm

3703-30-101  Nero - Black

3703-30-102  Bianco - White

3703-30-119  Ottone satinato - Satined brass

3703-30-178  Nichel satinato - Satined nickel

Regolazione luce al tocco
 Touch dimmer
 Variateur sensitif
 Touchdimmer

CE   IP20



3783

Vetro soffiato - Blown glass
Verre soufflé - Geblasenes Glas



table lamp



Blanc - Weiss



victoria 3783



G9 1x20W

3783-30-102 Bianco - White

Regolazione luce al tocco
Touch dimmer
Variateur sensitif
Touchdimmer

Lampadina G9 LED 3W dimmerabile inclusa
Bulb G9 LED 3W dimmable included
Ampoule G9 LED 3W dimmable incluse
G9 LED 3W dimmbares LM inklusive

CE IP20

3689

Struttura in metallo e vetro soffiato - Metal frame and blown glass
 Monture en métal et verre soufflé - Metallgestell und geblasenes Glas

collection:

page
140



page
295



page
440



Noir - Schwarz



table lamp



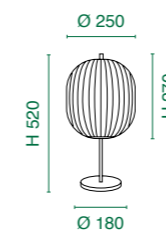

domizia 3689



E27 1x40W

3689-30-101 ■ Nero - Black

Con interruttore
 With switch
 Avec interrupteur
 Mit Schalter

CE   IP20

3775

Struttura in alluminio e metacrilato - Aluminium and methacrylate frame
 Monture en aluminium et méthacrylate - Aluminium und Methacrylat

collection:

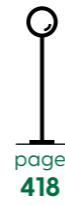

page
418

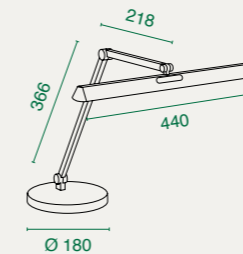

table lamp

- Blanc - Weiss
- Anthracite - Anthrazit



beba 3775



LED Warm white - Cold white 12W - 1340 lm

3775-30-102 Bianco - White

3775-30-282 Antracite - Anthracite

Regolazione luce al tocco
 Touch dimmer
 Variateur sensitif
 Touchdimmer

Orientabile - Adjustable
 Réglable - Schwenkbar

3000K - 4000K - 6000K

CE IP20



table lamp



regina 3551

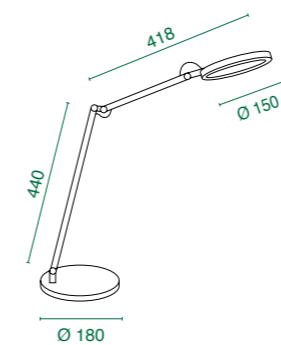

LED Warm white - Cold white 9W - 1135 lm

3551-30-101  Nero - Black



3551-30-102  Bianco - White

3551-30-212  Alluminio - Aluminum

Regolazione luce al tocco
Touch dimmer
Variateur sensitif
Touchdimmer

 Orientabile - Adjustable
Réglable - Schwenkbar

 3000K - 4000K - 5000K - 6000K

CE   IP20

 E

3550

Struttura in alluminio - Aluminum frame
Monture en aluminium - Aluminium

collection:

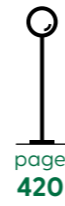

Noir - Schwarz Blanc - Weiss



table lamp

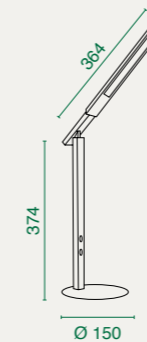

LED Warm white - Cold white 10W - 1000 lm

3550-30-101 Nero - Black

3550-30-102 Bianco - White

Regolazione luce al tocco
Touch dimmer
Variateur sensitif
Touchdimmer

Orientabile - Adjustable
Réglable - Schwenkbar

3000K - 4000K - 5000K - 6000K

CE IP20

3265

Struttura in metallo - Metal frame
Monture en métal - Metallgestell

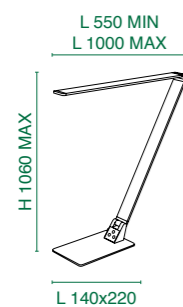

LED Warm white - Cold white 12W - 900 lm

3265-30-101 ■ Nero - Black

3265-30-212 ■ Alluminio spazzolato
Brushed aluminum

Regolazione luce al tocco
Touch dimmer
Variateur sensitif
Touchdimmer

Orientabile - Adjustable
Réglable - Schwenkbar

USB charger

3000K - 4000K - 5000K

CE IP20



Noir - Schwarz ■ Aluminium brossé - Aluminium gebürstet



panarea Design s.t. Fabas Luce

3675

Struttura in metallo - Metal frame
Monture en métal - Metallgestell

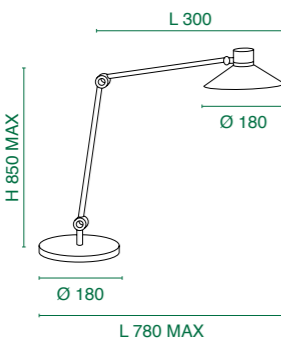

LED Warm white - Cold white 10W - 1020 lm

3675-30-101 ■ Nero - Black

3675-30-102 □ Bianco - White

Regolazione luce al tocco
Touch dimmer
Variateur sensitif
Touchdimmer

Orientabile - Adjustable
Réglable - Schwenkbar

3000K - 4000K - 5000K - 6000K

CE



Noir - Schwarz ■ □ Blanc - Weiss

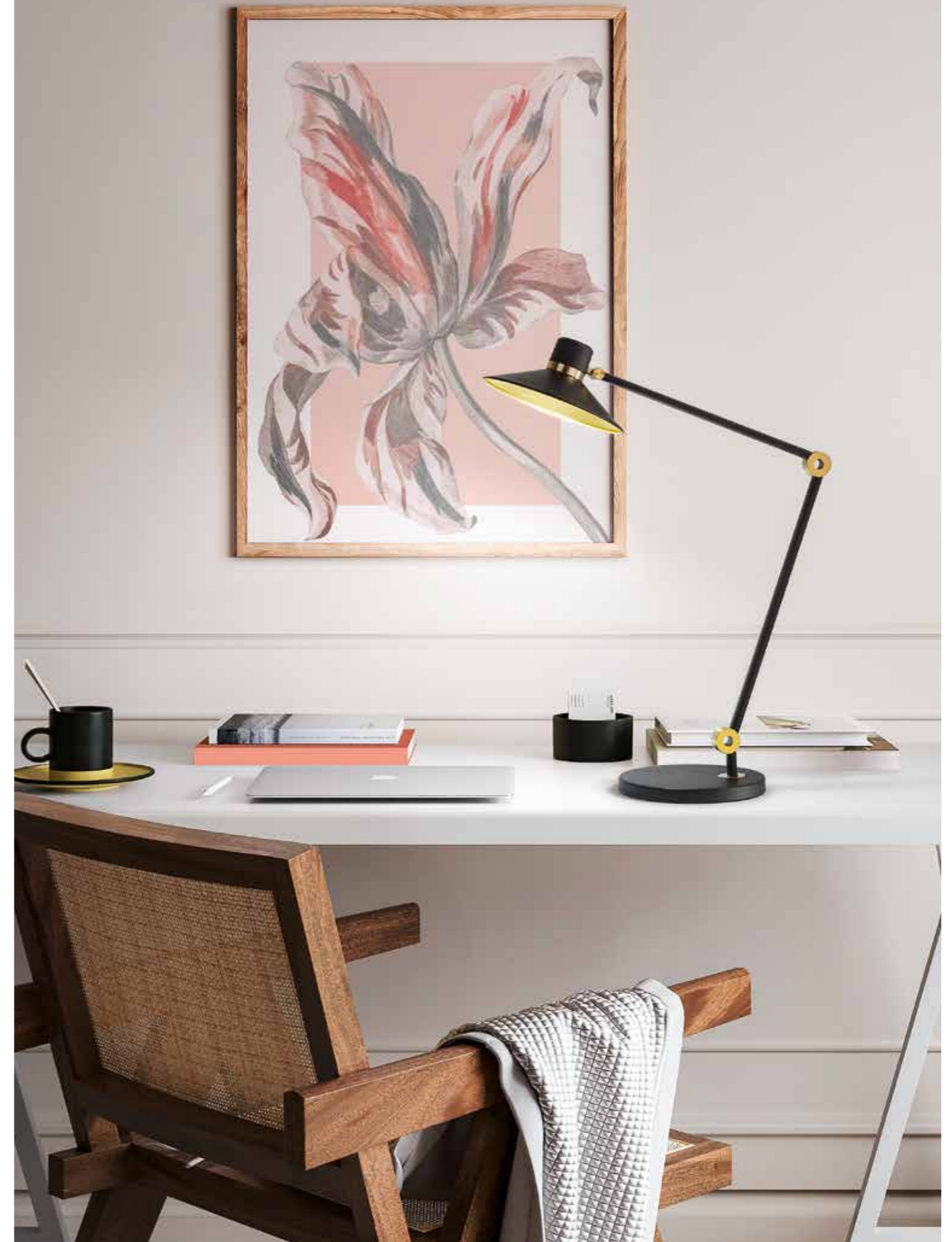

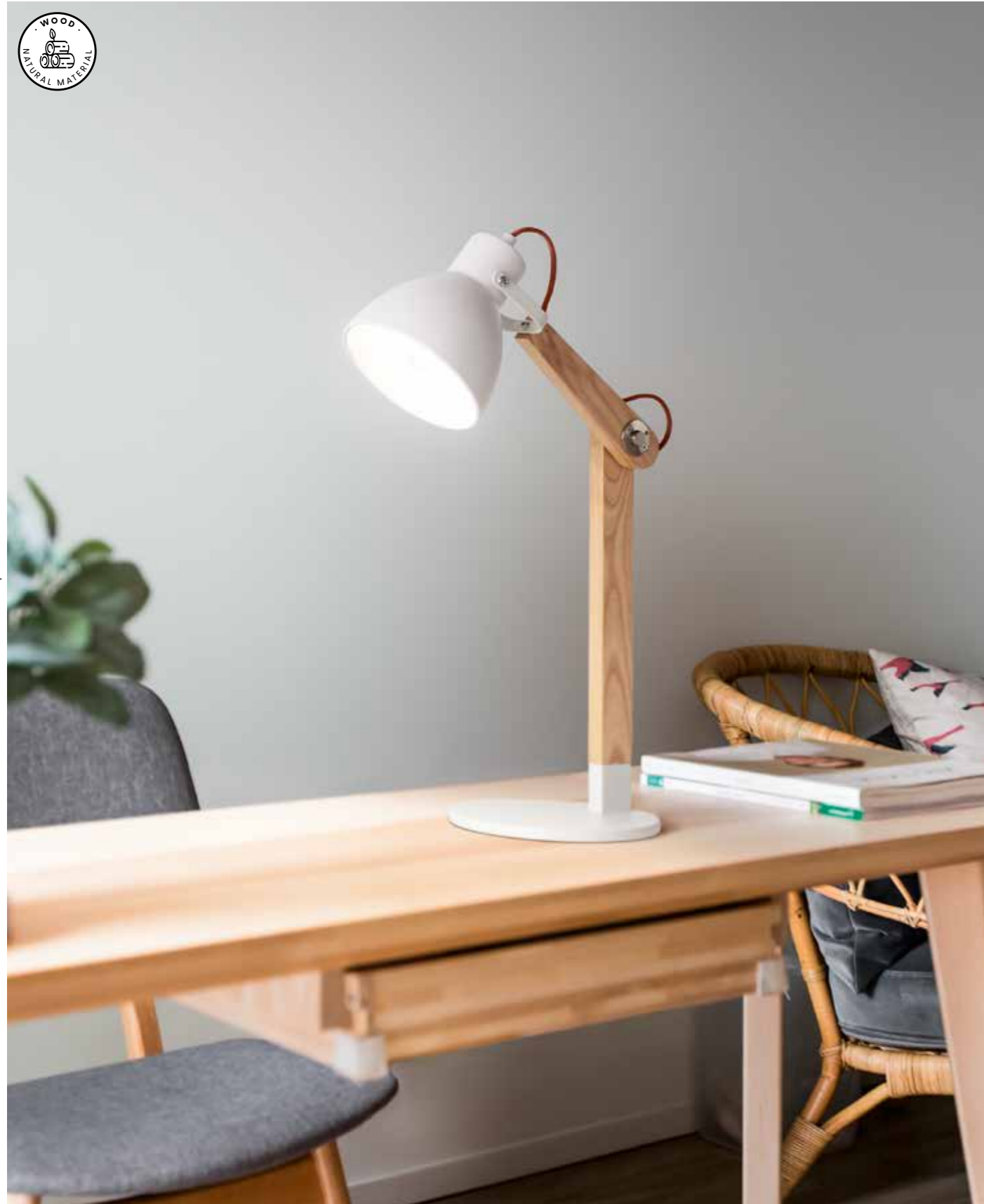

table lamp



SVEVA 3644





E27 1x60W

3644-30-101  Nero/Noce - Black/Walnut

3644-30-102  Bianco/Frassino - White/Ash wood

Con interruttore
With switch
Avec interrupteur
Mit Schalter

Orientabile - Adjustable
Réglable - Schwenkbar

CE   IP20

pierre

Blank Design Studio

3695

Struttura in metallo e legno - Metal frame and wood
 Monture en métal et en bois - Metall und Holz

collection: **page 155**

page 155



Noir - Schwarz Blanc - Weiss



table lamp

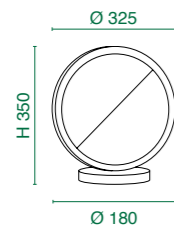

LED Warm white 3000K - 29W - 3160 lm

3695-30-101 Nero - Black

3695-30-102 Bianco - White

Regolazione luce al tocco
 Touch dimmer
 Variateur sensitif
 Touchdimmer



CE IP20



gisella

Design s.t. Fabas Luce

3518

Struttura in metallo e vetro soffiato - Metal frame and blown glass
 Monture en métal et verre soufflé - Metallgestell und geblasenes Glas

collection: **page 136**

page 136



Ambre - Amber

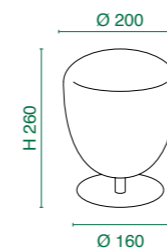

E27 1x40W

3518-30-125 Ambra - Amber

Con interruttore
 With switch
 Avec interrupteur
 Mit Schalter



CE IP20

3519

Struttura in metallo e vetro soffiato - Metal frame and blown glass
 Monture en métal et verre soufflé - Metallgestell und geblasenes Glas

collection:

page
114



■ Gris transparent - Grau transparent



table lamp



infinity 3519

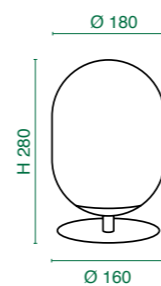

E27 1x40W

3519-30-126 ■ Fumé - Transparent grey

Con interruttore
 With switch
 Avec interrupteur
 Mit Schalter

CE IP20

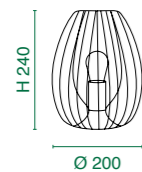
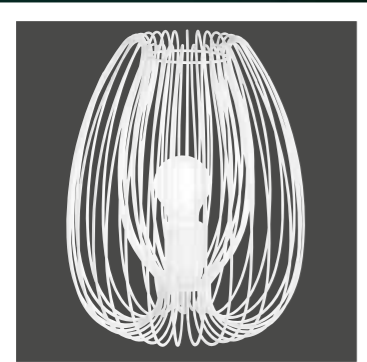

- E27 1x40W**
- 3677-34-101** Nero - Black
- 3677-34-102** Bianco - White
- 3677-34-225** Oro opaco - Gold matt
- Con interruttore
With switch
Avec interrupteur
Mit Schalter
- CE IP20

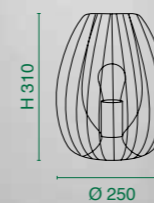

- E27 1x40W**
- 3677-30-101** Nero - Black
- 3677-30-102** Bianco - White
- 3677-30-225** Oro opaco - Gold matt
- Con interruttore
With switch
Avec interrupteur
Mit Schalter
- CE IP20

3386

Struttura in metallo e metacrilato - Metal and methacrylate frame
 Monture en métal et méthacrylate - Metall - und Methacrylatgestell

table lamp

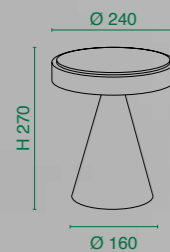

LED Warm white 3000K - 12W - 1260 lm

3386-35-101 ■ Nero - Black

3386-35-102 □ Bianco - White

3386-35-178 ■ Nichel satinato
Satined nickel

3386-35-225 ■ Oro opaco - Gold matt

3386-35-287 ■ Verde - Green

Regolazione luce al tocco
 Touch dimmer
 Variateur sensitif
 Touchdimmer

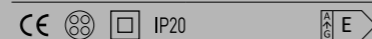

Noir - Schwarz ■ Blanc - Weiss □
 Nickel satiné - Nickel satiniert ■ Or mat - Gold edelmatt ■
 Vert - Grün ■

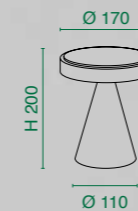

LED Warm white 3000K - 8W - 750 lm

3386-34-101 ■ Nero - Black

3386-34-102 □ Bianco - White

3386-34-178 ■ Nichel satinato
Satined nickel

3386-34-225 ■ Oro opaco - Gold matt

Regolazione luce al tocco
 Touch dimmer
 Variateur sensitif
 Touchdimmer

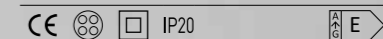

3625

Struttura in metallo e metacrilato - Metal and methacrylate frame
 Monture en métal et méthacrylate - Metall und Methacrylat

collection:

page
104



page
230



page
430



Blanc - Weiss

table lamp



vela 3625

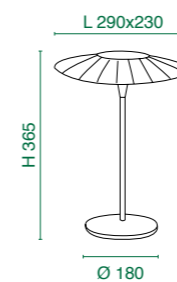

LED Warm white 3000K - 12W - 1100 lm

3625-30-102 Bianco - White

Dimmerabile a step
 Steps dimmable
 Gradable
 In Stufen dimmbar

CE IP20



3394

Struttura in metallo e metacrilato - Metal and methacrylate frame
Monture en métal et méthacrylate - Metall und Methacrylat

collection: page 94 page 216 page 268

Noir - Schwarz Blanc - Weiss
Or mat - Gold edelmatt Anthracite - Anthrazit
Corten - Rostbraun

table lamp



bard 3394



LED Warm white 3000K - 15W - 1720 lm

3394-30-101 Nero - Black

3394-30-102 Bianco - White

3394-30-225 Oro opaco - Gold matt

3394-30-282 Antracite - Anthracite

3394-30-361 Corten

Regolazione luce con pulsante
Push dimmer
Bouton poussoir dimmable
Tastdimmer

CE IP20

E

3414

Struttura in metallo e vetro soffiato - Metal frame and blown glass
 Monture en métal et verre soufflé - Metall und geblasenes Glas

collection: **page 302**

Blanc - Weiss   Argent - Silber
 Or mat - Gold edelmatt 



table lamp



adria 3414

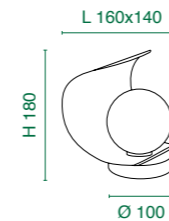





LED Warm white 3000K - 6W - 540 lm

3414-30-102  Bianco - White

3414-30-137  Argento - Silver

3414-30-225  Oro opaco - Gold matt

Regolazione luce al tocco
 Touch dimmer
 Variateur sensitif
 Touchdimmer

   IP20 

3407

Struttura in metallo e vetro soffiato - Metal frame and blown glass
 Monture en métal et verre soufflé - Metall und geblasenes Glas



table lamp



Blanc - Weiss Nickel satiné - Nickel satiniert
 Or mat - Gold edelmatt

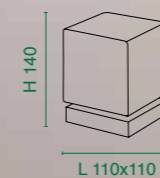

LED Warm white 3000K - 6W - 540 lm

3407-30-102 Bianco - White

3407-30-178 Nickel satinato
 Satined nickel

3407-30-225 Oro opaco - Gold matt

Regolazione luce al tocco
 Touch dimmer
 Variateur sensitif
 Touchdimmer

CE IP20

E

brenta 3407

gravity

Design Variaforma

3360

Struttura in metallo e vetro soffiato - Metal frame and blown glass
Monture en métal et verre soufflé - Metall und geblasenes Glas



table lamp



Blanc - Weiss Nickel satiné - Nickel satiniert



gravity 3360



LED Warm white 3000K - 5W - 470 lm

3360-30-102 Bianco - White

3360-30-178 Nichel satinato
Satined nickel

Regolazione luce al tocco
Touch dimmer
Variateur sensitif
Touchdimmer

CE IP20

E

3257

Struttura in metallo e vetro soffiato - Metal frame and blown glass
 Monture en métal et verre soufflé - Metall und geblasenes Glas

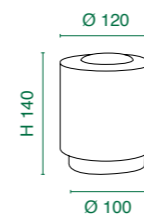

table lamp

Chromé - Verchromt Nickel satiné - Nickel satiniert



simi 3257



LED Warm white 3000K - 8W - 750 lm

3257-30-138 Cromo - Chrome

3257-30-178 Nichel satinato
 Satined nickel

Regolazione luce al tocco
 Touch dimmer
 Variateur sensitif
 Touchdimmer

CE IP20





E

Struttura in metallo e vetro soffiato - Metal frame and blown glass
Monture en métal et verre soufflé - Metall und geblasenes Glas

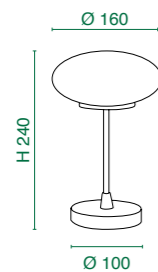
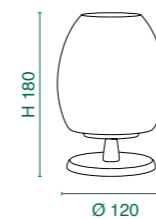





table lamp



LED Warm white 3000K - 5W - 500 lm
3339-30-178  Nickel satinato
Satined nickel
Regolazione luce al tocco
Touch dimmer
Variateur sensitif
Touchdimmer
CE   IP20 

Struttura in metallo e vetro soffiato - Metal frame and blown glass
Monture en métal et verre soufflé - Metall und geblasenes Glas





G9 1x33W
3571-30-102  Bianco - White
Regolazione luce al tocco
Touch dimmer
Variateur sensitif
Touchdimmer
Lampadina G9 LED 3W dimmerabile inclusa
Bulb G9 LED 3W dimmable included
Ampoule G9 LED 3W dimmable incluse
G9 LED 3W dimmbares LM inklusive
CE   IP20

3579



Struttura in metallo e vetro soffiato - Metal frame and blown glass
 Monture en metal et verre soufflé - Metallgestell und geblasenes Glas

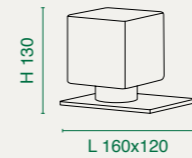

table lamp

Noir - Schwarz   Blanc - Weiss
 Nickel satiné - Nickel satiniert 



- G9** 1x33W
- 3579-30-101**  Nero - Black
- 3579-30-102**  Bianco - White
- 3579-30-178**  Nichel satinato
Satined nickel

Regolazione luce al tocco
 Touch dimmer
 Variateur sensitif
 Touchdimmer

Lampadina G9 LED 3W dimmerabile inclusa
 Bulb G9 LED 3W dimmable included
 Ampoule G9 LED 3W dimmable incluse
 G9 LED 3W dimmbares LM inklusive

CE    IP20

3568

Struttura in metallo e vetro soffiato - Metal frame and blown glass
 Monture en métal et verre soufflé - Metall und geblasenes Glas



Noir - Schwarz 
 Nickel satiné - Nickel satiniert 



table lamp

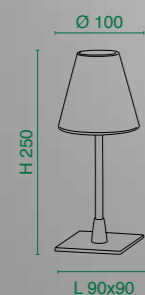

G9 1x33W
3568-30-101  Nero - Black
3568-30-178  Nichel satinato
 Satined nickel
 Regolazione luce al tocco
 Touch dimmer
 Variateur sensitif
 Touchdimmer
 Lampadina G9 LED 3W dimmerabile inclusa
 Bulb G9 LED 3W dimmable included
 Ampoule G9 LED 3W dimmable incluse
 G9 LED 3W dimmbares LM inklusive
 CE   IP20

2653



Struttura in metallo e vetro soffiato - Metal frame and blown glass
 Monture en métal et verre soufflé - Metall und geblasenes Glas

Nichel satiné - Nickel satiniert 

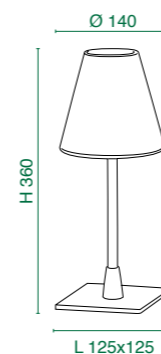

lucy 3568 - 2653



E14 1x60W
2653-31-178  Nichel satinato
 Satined nickel
 Accensione al tocco
 Touch switch
 Allumage tactile
 Tastschaltung
 CE   IP20

gaia

Design s.t. Fabas Luce

3569

Struttura in metallo e vetro soffiato - Metal frame and blown glass
 Monture en métal et verre soufflé - Metall und geblasenes Glas





Noir - Schwarz 
 Nickel satiné - Nickel satiniert 



table lamp



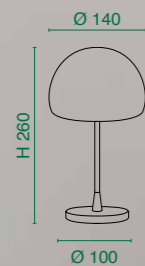

G9 1x33W

3569-30-101  Nero - Black

3569-30-178  Nickel satinato
 Satined nickel

Regolazione luce al tocco
 Touch dimmer
 Variateur sensitif
 Touchdimmer

Lampadina G9 LED 3W dimmerabile inclusa
 Bulb G9 LED 3W dimmable included
 Ampoule G9 LED 3W dimmable incluse
 G9 LED 3W dimmbares LM inklusive

CE   IP20

gaia big

Design s.t. Fabas Luce

2654

Struttura in metallo e vetro soffiato - Metal frame and blown glass
 Monture en métal et verre soufflé - Metall und geblasenes Glas

Nickel satiné - Nickel satiniert 



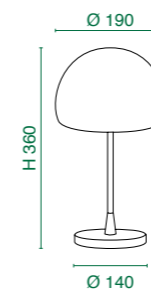

gaia 3569 - 2654



E14 1x40W

2654-31-178  Nickel satinato
 Satined nickel

Accensione al tocco
 Touch switch
 Allumage tactile
 Tastschaltung

CE   IP20

morgana

Design s.t. Fabas Luce

3570

Struttura in metallo e vetro soffiato - Metal frame and blown glass
 Monture en métal et verre soufflé - Metall und geblasenes Glas



table lamp



- Noir - Schwarz
- Chromé - Verchromt
- Nickel satiné - Nickel satiniert



morgana 3570

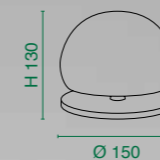

G9 1x33W

- 3570-30-101** Nero - Black
- 3570-30-138** Cromo - Chrome
- 3570-30-178** Nichel satinato
Satined nickel

Regolazione luce al tocco

- Touch dimmer
- Variateur sensitif
- Touchdimmer

Lampadina G9 LED 3W dimmerabile inclusa
 Bulb G9 LED 3W dimmable included
 Ampoule G9 LED 3W dimmable incluse
 G9 LED 3W dimmbares LM inklusive

CE IP20

3576

Struttura in metallo e vetro soffiato - Metal frame and blown glass
 Monture en métal et verre soufflé - Metall und geblasenes Glas



table lamp

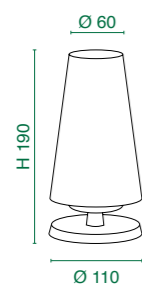

G9 1x33W

3576-30-101 ■ Nero - Black

3576-30-178 ■ Nichel satinato
 Satined nickel

Regolazione luce al tocco
 Touch dimmer
 Variateur sensitif
 Touchdimmer

Lampadina G9 LED 3W dimmerabile inclusa
 Bulb G9 LED 3W dimmable included
 Ampoule G9 LED 3W dimmable incluse
 G9 LED 3W dimmbares LM inklusive

CE IP20

Noir - Schwarz ■ ■ Nickel satiné - Nickel satiniert

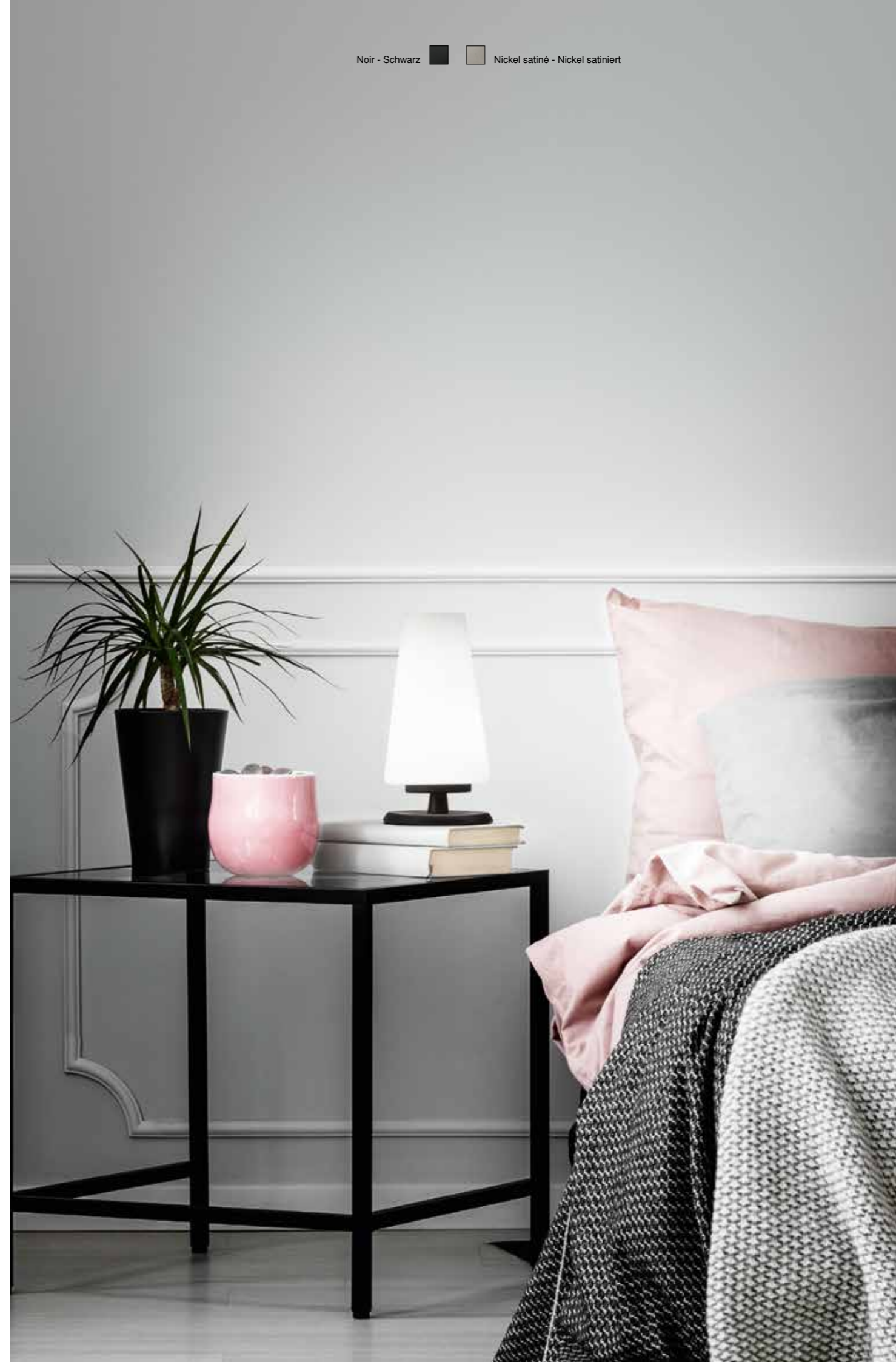

milady 3576

2533

Struttura in metallo e vetro soffiato - Metal frame and blown glass
 Monture en métal et verre soufflé - Metall und geblasenes Glas



table lamp



Blanc - Weiss



ade 2533

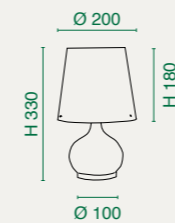

E14 1x60W
G9 1x25W
2533-34-102 Bianco - White
 Con doppia accensione
 With double lighting
 Avec double allumage
 Getrennt schaltbar
 CE IP20

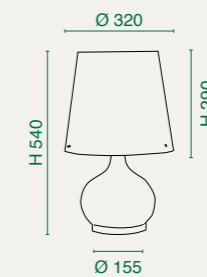

E27 1x100W
E14 1x40W
2533-35-102 Bianco - White
 Con doppia accensione
 With double lighting
 Avec double allumage
 Getrennt schaltbar
 CE IP20

marbella

Design s.t. Fabas Luce

Blanc - Weiss

3527

Struttura in metallo e ceramica - Metal and ceramic frame
Structure métal et céramique - Metall- und Keramikstruktur



table lamp

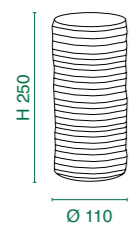

E27 1x40W
3527-30-102 Bianco - White
Con interruttore
With switch
Avec interrupteur
Mit Schalter
CE

micol

Design s.t. Fabas Luce

Blanc - Weiss

3528

Struttura in metallo e ceramica - Metal and ceramic frame
Structure métal et céramique - Metall- und Keramikstruktur

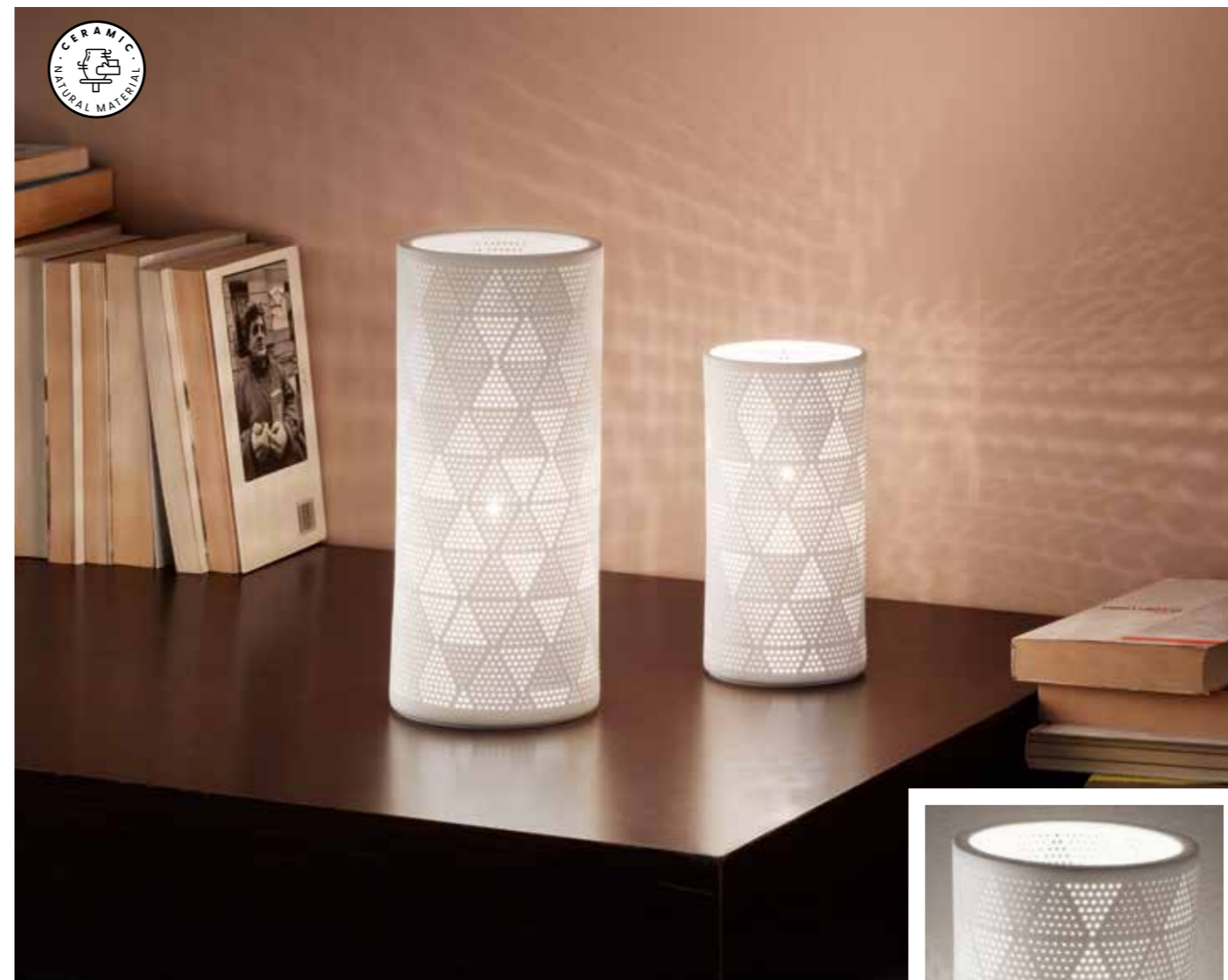

E27 1x40W
3528-30-102 Bianco - White
Con interruttore
With switch
Avec interrupteur
Mit Schalter
CE



E27 1x40W
3528-35-102 Bianco - White
Con interruttore
With switch
Avec interrupteur
Mit Schalter
CE

3760

Struttura in metallo e plastica vegetale - Metal frame and bio-based plastic
 Monture en métal et plastique végétal - Metall und biobasierter Kunststoff



table lamp



Blanc - Weiss Couleur moutard - Senffarbe
 Bordeaux



Prodotto realizzato con stampanti 3D utilizzando plastica biologica PLA.
 Product made with 3D printers using PLA biological plastic.
 Produit fabriqué avec des imprimantes 3D utilisant du plastique biosourcé PLA.
 Produkt hergestellt mit 3D-Druckern aus biobasiertem PLA-Kunststoff.



G9 1x10W

3760-30-102 Bianco - White

3760-30-133 Bordeaux - Burgundy

3760-30-367 Senape - Mustard colored

Regolazione luce al tocco
 Touch dimmer
 Variateur sensitif
 Touchdimmer

Lampadina G9 LED 3W dimmerabile inclusa
 Bulb G9 LED 3W dimmable included
 Ampoule G9 LED 3W dimmable incluse
 G9 LED 3W dimmbares LM inklusive

CE IP20

nadine 3760

thalia

Design s.t. Fabas Luce

3511

Struttura in plastica e alluminio - Plastic and aluminum frame
Monture plastique et aluminium - Kunststoff und Aluminiumstruktur

Blanc - Weiss



table lamp



Lampada da tavolo con sensore di gravità:
cambia automaticamente tra luce calda e
fredda a seconda dell'orientamento.

Table lamp with gravity sensor:
automatically switches between warm and
cold light depending on orientation.

Lampe de table avec capteur de gravité:
change automatiquement entre lumière
chaude et froide selon l'orientation.

Tischlampe mit Schwerkraftsensor:
wechselt automatisch zwischen warmem
und kaltem Licht je nach Ausrichtung.



Thalia 3511

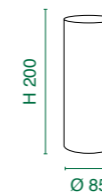

LED Warm white - Cold white 2,5W - 325 lm

3511-30-137 Bianco - White

Regolazione luce al tocco
Touch dimmer
Variateur sensitif
Touchdimmer

Ricaricabile - Rechargeable
Réglable - Wiederaufladbar

Gravity sensor

2700K - 5000K

CE

3509

Struttura in plastica - Plastic frame
Monture plastique - Kunststoff

table lamp



Blanc - Weiss Vert - Grün



bluma 3509

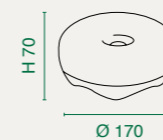

LED Warm white 3000K - 3,9W - 325 lm

3509-30-102 Bianco - White

3509-30-155 Verde - Green

Dimmerazione a sensore
Sensor dimming
Capteur gradateur
Sensordimmer

Ricaricabile - Rechargeable
Réglable - Wiederaufladbar

CE IP20

F



floor lamp

3807

Struttura in metallo e metacrilato - Metal and methacrylate frame
Monture en métal et méthacrylate - Metall und Methacrylat



floor lamp



Blanc - Weiss Rouge - Rot
Anthracite - Anthrazit



fizz 3807



Blanc - Weiss Rouge - Rot
 Anthracite - Anthrazit

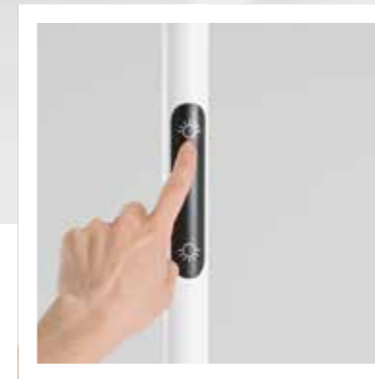
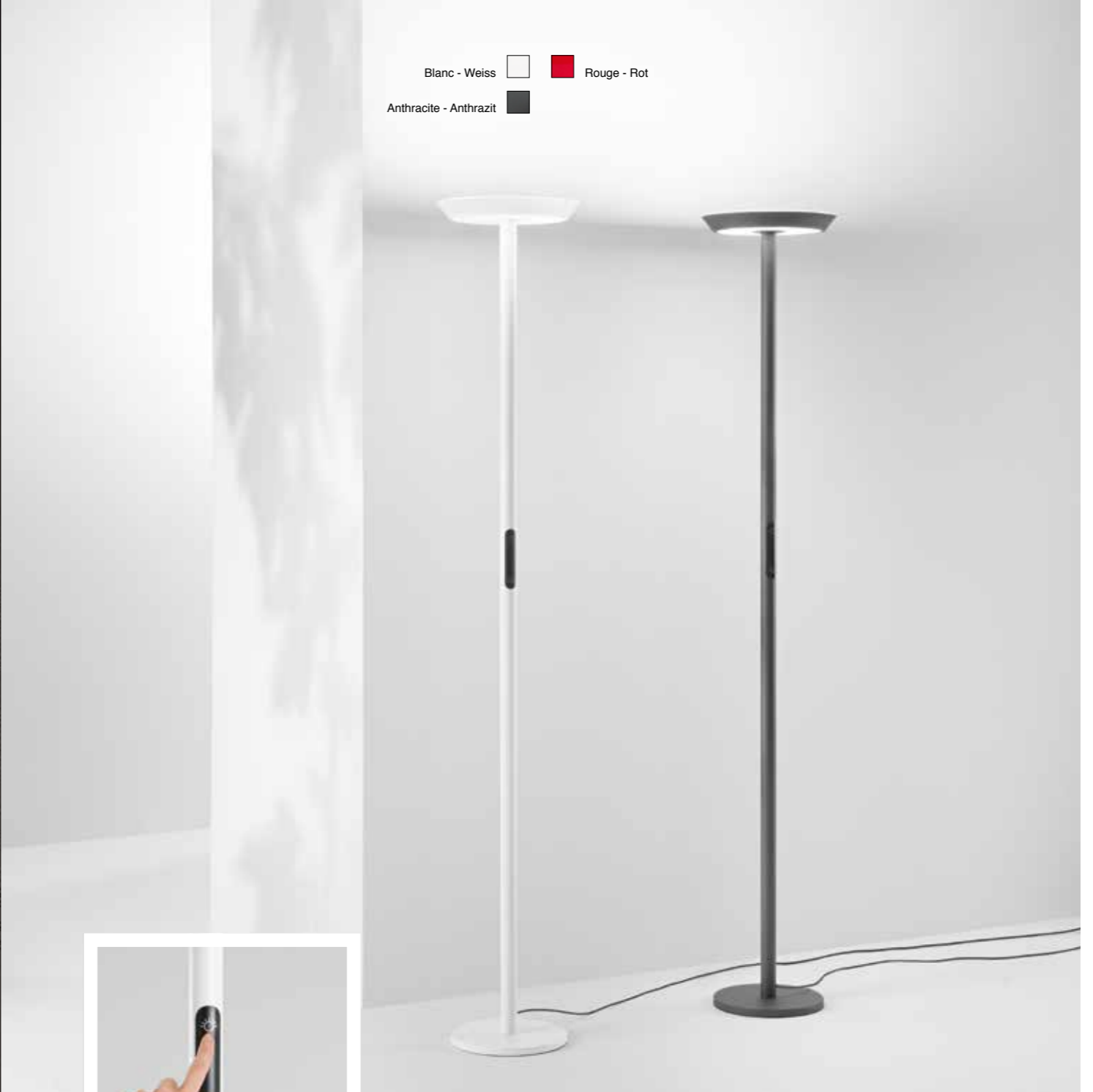

Dimmerazione e cambio temperatura colore della luce superiore e inferiore indipendenti.
 Independent dimming and colour temperature change of top and bottom light.
 Variation indépendante de l'intensité lumineuse et de la température de couleur de l'éclairage supérieur et inférieur.
 Unabhängiges Dimmen und Ändern der Farbtemperatur des oberen und unteren Lichts.

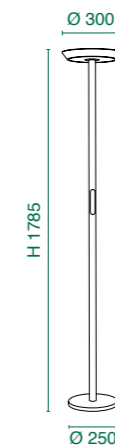

LED Warm white - Natural white 50+10W - 3300+900 lm

3807-10-102 Bianco - White

3807-10-104 Rosso - Red

3807-10-282 Antracite - Anthracite

Regolazione luce al tocco
 Touch dimmer
 Variateur sensitif
 Touchdimmer

2700K - 3200K - 4000K

CE IP20

E

3786

Struttura in metallo e metacrilato - Metal and methacrylate frame
 Monture en métal et méthacrylate - Metall und Methacrylat



floor lamp



- Blanc - Weiss
- Rouge - Rot
- Anthracite - Anthrazit

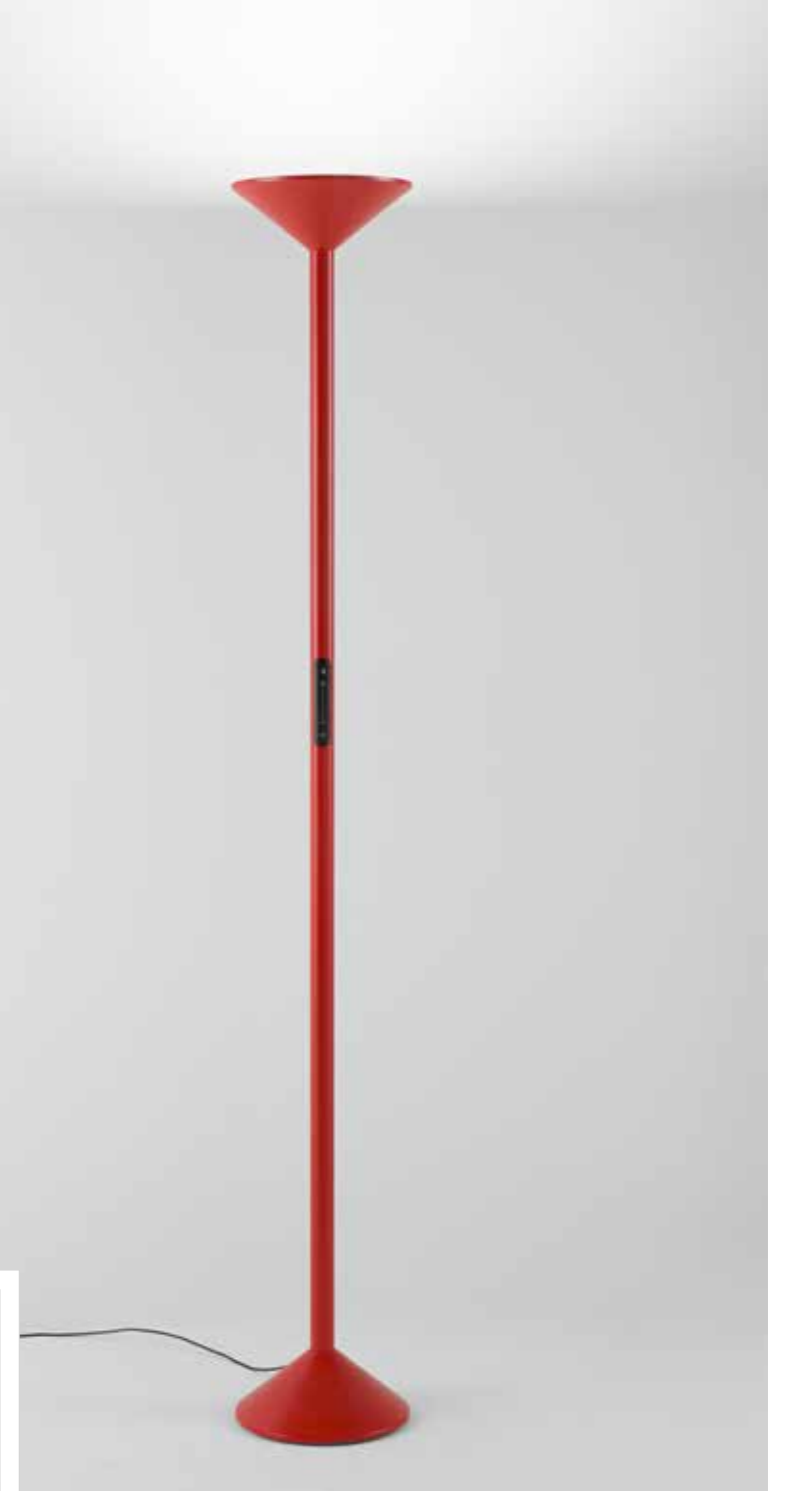

tratto 3786



LED Warm white - Natural white 50W - 4000 lm

3786-10-102 Bianco - White

3786-10-104 Rosso - Red

3786-10-282 Antracite - Anthracite

Regolazione luce al tocco
 Touch dimmer
 Variateur sensitif
 Touchdimmer

2700K - 3200K - 4000K

CE IP20

Blanc - Weiss Rouge - Rot
Anthracite - Anthrazit

floor lamp

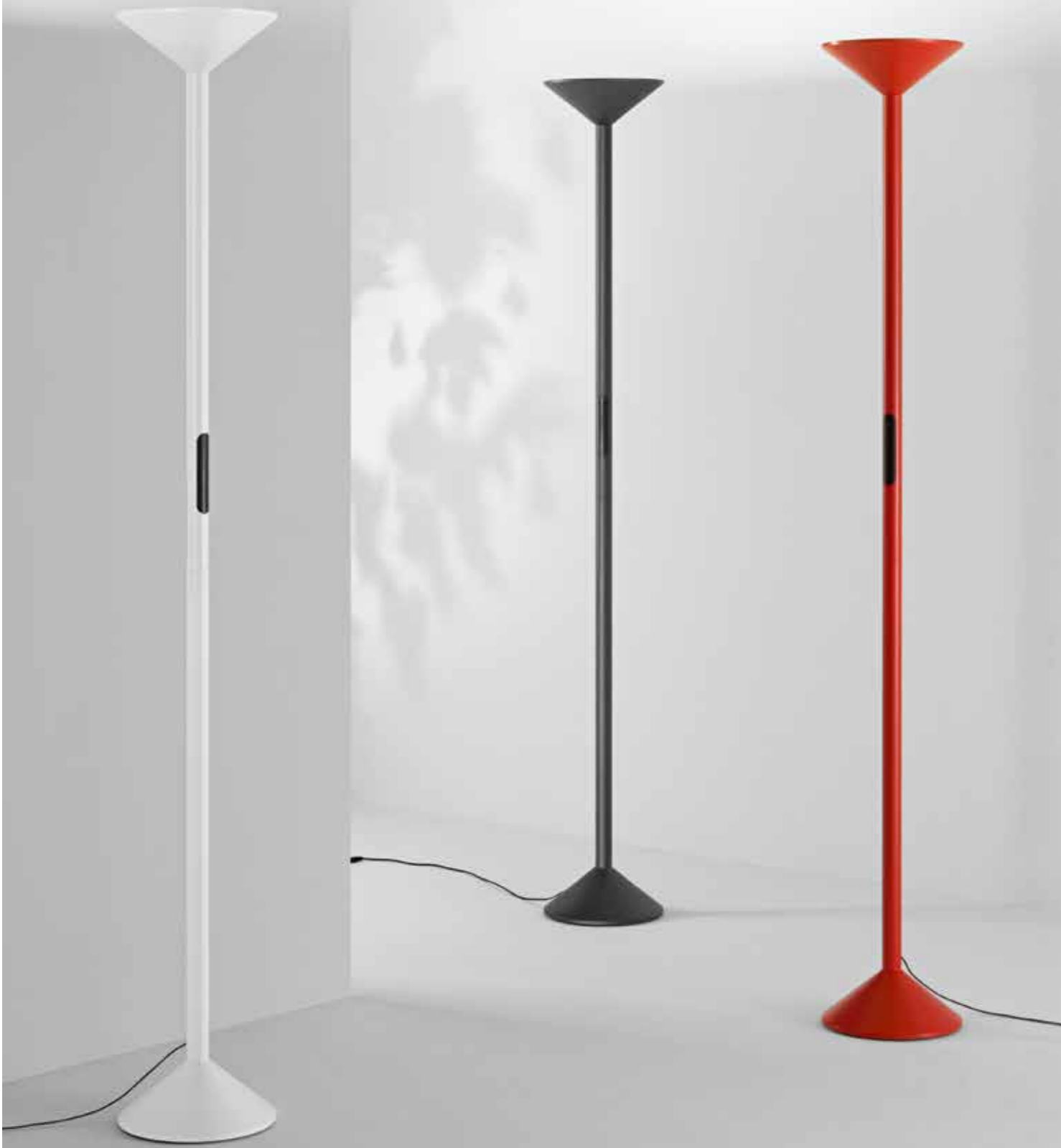

tratto 3786

3775

Struttura in alluminio e metacrilato - Aluminium and methacrylate frame
Monture en aluminium et méthacrylate - Aluminium und Methacrylat

collection:



page
354



floor lamp



Blanc - Weiss

Anthracite - Anthrazit

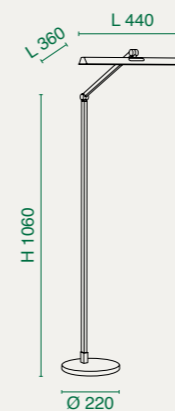

LED Warm white - Cold white 12W - 1340 lm

3775-11-102 Bianco - White

3775-11-282 Antracite - Anthracite

Regolazione luce al tocco
Touch dimmer
Variateur sensitif
Touchdimmer

Orientabile - Adjustable
Réglable - Schwenkbar

3000K - 4000K - 6000K

CE IP20



floor lamp

Noir - Schwarz Blanc - Weiss



ideal 3550



LED Warm white - Cold white 35W - 3500 lm

3550-12-101 Nero - Black

3550-12-102 Bianco - White

Regolazione luce al tocco
Touch dimmer
Variateur sensitif
Touchdimmer

Orientabile - Adjustable
Réglable - Schwenkbar

3000K - 4000K - 5000K - 6000K

CE IP20

E

Noir - Schwarz Blanc - Weiss

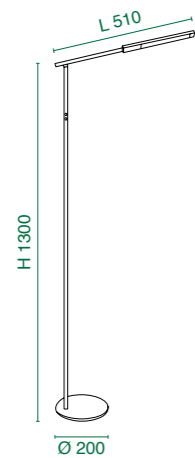

LED Warm white - Cold white 10W - 1000 lm

3550-11-101 Nero - Black

3550-11-102 Bianco - White

Regolazione luce al tocco
Touch dimmer
Variateur sensitif
Touchdimmer

Orientabile - Adjustable
Réglable - Schwenkbar

3000K - 4000K - 5000K - 6000K

CE IP20

Noir - Schwarz Blanc - Weiss

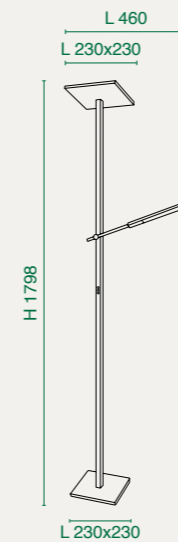

LED Warm white 3000K - 40W+8W - 3050 + 670 lm

3550-10-101 Nero - Black

3550-10-102 Bianco - White

Regolazione luce al tocco
Touch dimmer
Variateur sensitif
Touchdimmer

Orientabile - Adjustable
Réglable - Schwenkbar

CE IP20

floor lamp

ideal 3550



floor lamp



Noir - Schwarz Blanc - Weiss



LED Warm white - Cold white 35W - 3500 lm

3551-12-101 Nero - Black

3551-12-102 Bianco - White

Regolazione luce al tocco
Touch dimmer
Variateur sensitif
Touchdimmer

Orientabile - Adjustable
Réglable - Schwenkbar

3000K - 4000K - 5000K - 6000K

CE IP20

E

floor lamp



Noir - Schwarz Blanc - Weiss

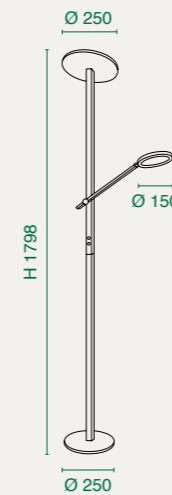

LED Warm white 3000K - 36W/12W - 3050/1100 lm

3551-10-101 Nero - Black

3551-10-102 Bianco - White



Regolazione luce al tocco
Touch dimmer
Variateur sensitif
Touchdimmer

Orientabile - Adjustable
Réglable - Schwenkbar

CE IP20

F

regina 3551

Noir - Schwarz   Blanc - Weiss
 Aluminium - Aluminium 

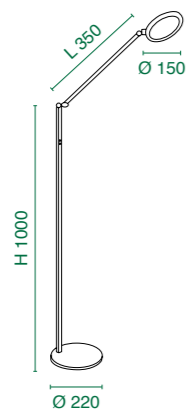



LED Warm white - Cold white 9W - 1135 lm

3551-11-101  Nero - Black

3551-11-102  Bianco - White

3551-11-212  Alluminio - Aluminum

 Regolazione luce al tocco
 Touch dimmer
 Variateur sensitif
 Touchdimmer

 Orientabile - Adjustable
 Réglable - Schwenkbar

 3000K - 4000K - 5000K - 6000K

CE   IP20  E

floor lamp 



regina 3551

3625

Struttura in metallo e metacrilato - Metal and methacrylate frame
 Monture en métal et méthacrylate - Metall und Methacrylat

collection:

page
104

page
230

page
374

Blanc - Weiss

floor lamp



vela 3625

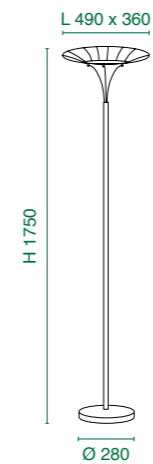

LED Warm white 3000K - 24W - 2180 lm

3625-10-102 Bianco - White

Dimmerabile a step
 Steps dimmable
 Gradable
 In Stufen dimmbar

CE IP20

F

3750

Struttura in metallo e vetro soffiato - Metal frame and blown glass
 Monture en métal et verre soufflé - Metall und geblasenes Glas

collection: page 142



floor lamp



Anthracite - Anthrazit
 Couleur sablé - Sandfarben
 Couleur brique - Ziegelfarbe



loto 3750

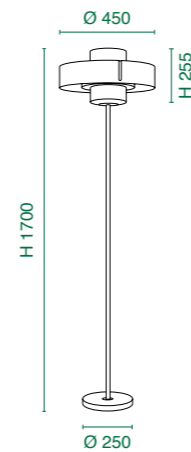

E27 1x40W

3750-10-282 ■ Anthracite - Anthracite

3750-10-355 ■ Sabbia - Sand

3750-10-358 ■ Mattone - Brick

Con variatore - With dimmer
 Avec variateur - Mit Dimmer

CE IP20



floor lamp



SVEVA 3644

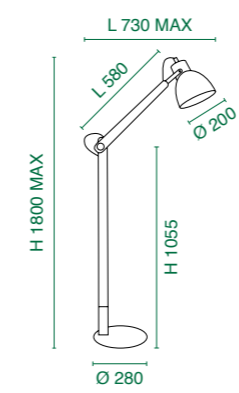



E27 1x60W

3644-11-101  Nero/Noce
Black/Walnut

3644-11-102  Bianco/Frassino
White/Ash wood

⏻ Con interruttore - With switch
Avec interrupteur - Mit Schalter

↕ Orientabile - Adjustable
Réglable - Schwenkbar

CE   IP20

3697

Struttura in metallo e legno - Metal frame and wood
 Monture en métal et en bois - Metall und Holz

collection: page 152 page 290

 Blanc - Weiss



floor lamp 





cordoba 3697



LED Warm white 3000K - 35W - 3740 lm

3697-10-102  Bianco - White

 Con variatore - With dimmer
 Avec variateur - Mit Dimmer

CE  IP20





floor lamp

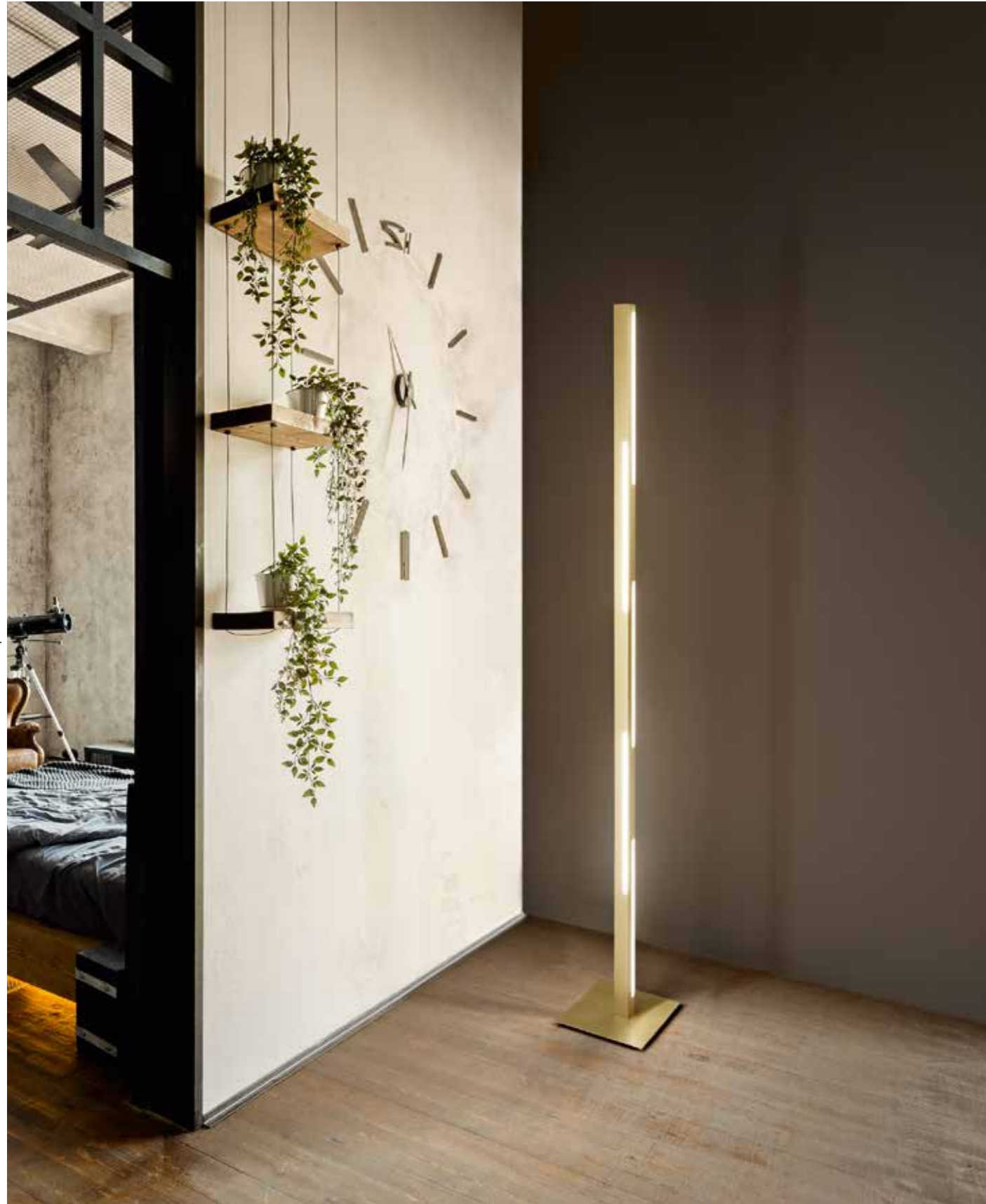



ling 3712





LED Warm white 3000K - 36W - 4320 lm

3712-10-101  Nero - Black

3712-10-119  Ottone satinato
Satinated brass

 Con variatore - With dimmer
Avec variateur - Mit Dimmer

CE   IP20

 F

3689

Struttura in metallo e vetro soffiato - Metal frame and blown glass
Monture en métal et verre soufflé - Metallgestell und geblasenes Glas

collection: page 140 page 295 page 352



floor lamp

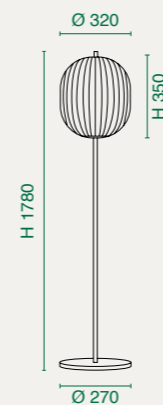

■ Noir - Schwarz

E27 1x40W

3689-10-101 ■ Nero - Black

Con variatore - With dimmer
Avec variateur - Mit Dimmer

CE IP20

 Kit LUCI

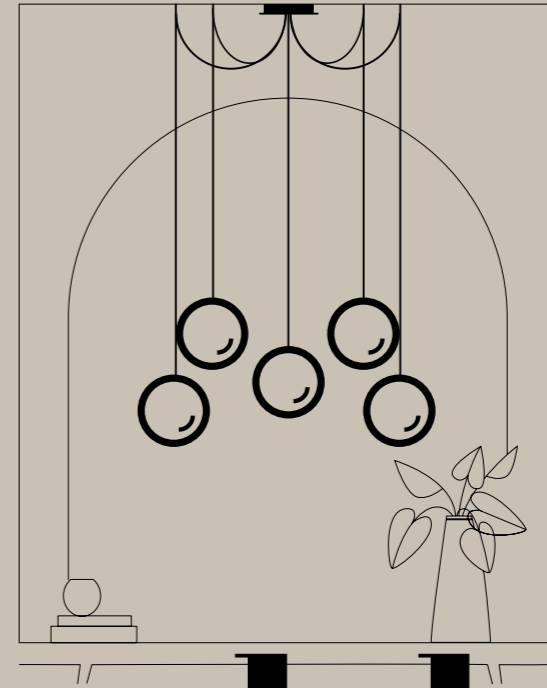

modular suspension

Montatura in metallo, vetro borosilicato o vetro soffiato - Metal frame, borosilicate glass or blown glass
 Monture en métal, verre borosilicaté ou verre soufflé - Metall, Borsilicatglas oder geblases Glas

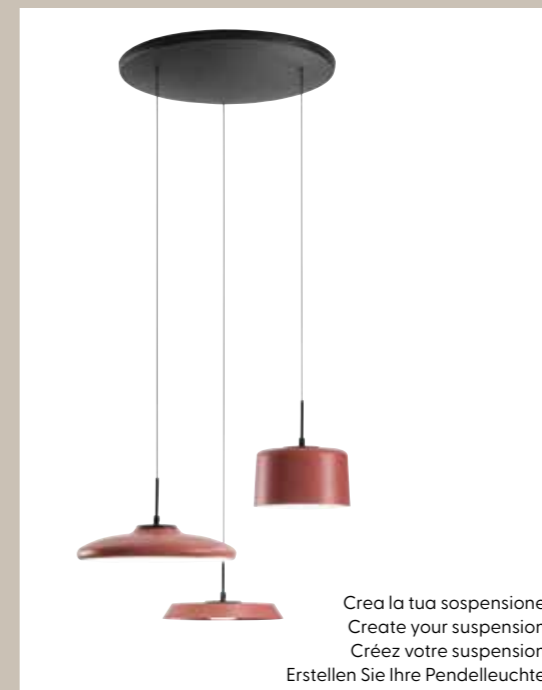
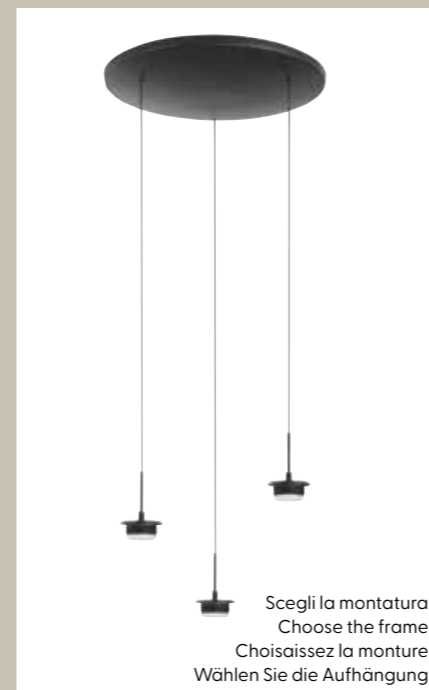

IT - L'illuminatore è provvisto di un circuito integrato a LED da 8W/14W protetto da un disco di metacrilato. Sotto questo disco è presente una levetta che permette all'utente di selezionare la temperatura colore della luce desiderata (2700K-3000K-4000K) creando configurazioni di illuminazione altamente personalizzate.

EN - The illuminator is equipped with an 8W/14W integrated LED circuit protected by a methacrylate cover. Under this cover, there is a smaller lever that allows the user to select the desired light color temperature (2700K-3000K-4000K) creating highly customized lighting configurations

FR - L'illuminateur est équipé d'un circuit LED intégré de 8W/14W protégé par une couverture en méthacrylate. Sous cette couverture, il y a un petit levier qui permet à l'utilisateur de sélectionner la température de couleur de lumière désirée (2700K-3000K-4000K) créant des configurations d'éclairage hautement personnalisées.

DE - Das Leuchtelement ist mit einer integrierten 8W/14W LED Platine ausgestattet, die durch eine Methacrylat-Abdeckung geschützt ist. Unter dieser Abdeckung befindet sich ein kleiner Hebel, mit dem der Benutzer die gewünschte Lichtfarbtemperatur (2700K-3000K-4000K) auswählen kann, wodurch hochgradig angepasste Beleuchtungskonfigurationen entstehen.

2700 K

3000 K

4000 K



kit luci LED 8W

Montatura / Frame / Monture / Aufhängung

Dimmerabile a step
 Steps dimmable
 Gradable
 In Stufen dimmbar
 2700K - 3000K - 4000K

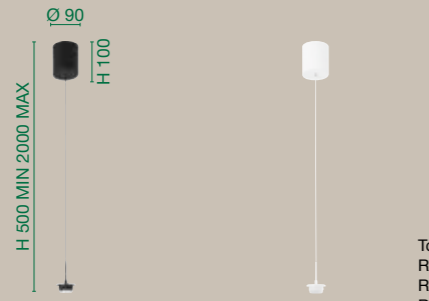

3804-45-101
 8W - 750 lm

Tonda 1 luce saliscendi
 Round 1 light raise & fall
 Ronde 1 lumière monte et baisse
 Rund 1-flammig zugpendel

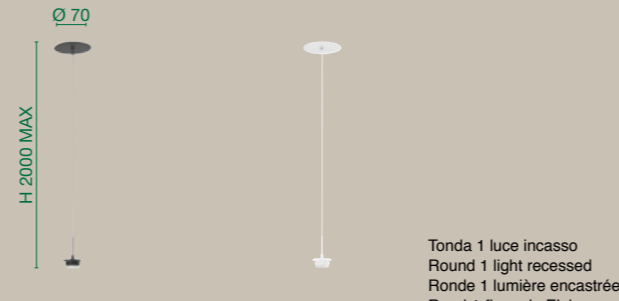

3804-40-101
 8W - 750 lm

Tonda 1 luce incasso
 Round 1 light recessed
 Ronde 1 lumière encastrée
 Rund 1-flammig Einbau

Nero - Black - Noir - Schwarz
 Cavo nero - Black cable
 Câble noir - Schwarzes Kabel

Bianco - White - Blanc - Weiss
 Cavo trasparente - Transparent cable
 Câble transparent - Transparentes Kabel

Nero - Black - Noir - Schwarz
 Cavo nero - Black cable
 Câble noir - Schwarzes Kabel

Bianco - White - Blanc - Weiss
 Cavo trasparente - Transparent cable
 Câble transparent - Transparentes Kabel



3804-41-101
 8W - 750 lm



3804-41-102
 8W - 750 lm

Tonda 1 luce
 Round 1 light
 Ronde 1 lumière
 Rund 1-flammig

Nero - Black - Noir - Schwarz
 Cavo nero - Black cable
 Câble noir - Schwarzes Kabel

Bianco - White - Blanc - Weiss
 Cavo trasparente - Transparent cable
 Câble transparent - Transparentes Kabel



3804-47-101
 21W - 2550 lm

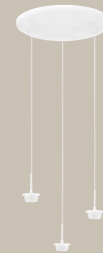

3804-47-102
 21W - 2550 lm

Tonda 3 luci Ø 350
 Round 3 lights Ø 350
 Ronde 3 lumières Ø 350
 Rund 3-flammig Ø 350

Nero - Black - Noir - Schwarz
 Cavo nero - Black cable
 Câble noir - Schwarzes Kabel

Bianco - White - Blanc - Weiss
 Cavo trasparente - Transparent cable
 Câble transparent - Transparentes Kabel



3804-49-101
 35W - 3750 lm



3804-49-102
 35W - 3750 lm

Tonda 5 luci Ø 500
 Round 5 lights Ø 500
 Ronde 5 lumières Ø 500
 Rund 5-flammig Ø 500

Nero - Black - Noir - Schwarz
 Cavo nero - Black cable
 Câble noir - Schwarzes Kabel

Bianco - White - Blanc - Weiss
 Cavo trasparente - Transparent cable
 Câble transparent - Transparentes Kabel

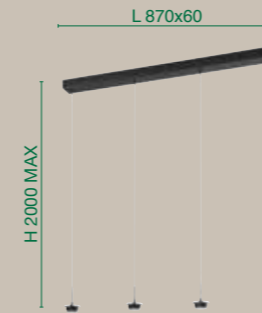

3804-48-101
 28W - 3000 lm

Nero - Black - Noir - Schwarz
 Cavo nero - Black cable
 Câble noir - Schwarzes Kabel



3804-48-102
 28W - 3000 lm

Bianco - White - Blanc - Weiss
 Cavo trasparente - Transparent cable
 Câble transparent - Transparentes Kabel

Rettangolare 4 luci
 Rectangular 4 lights
 Rectangulaire 4 lumières
 Rechteckig 4-flammig

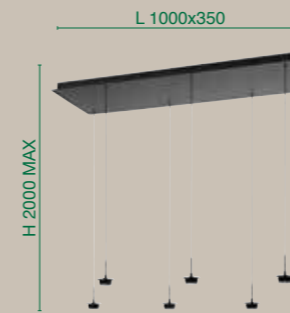

3804-46-101
 42W - 4500 lm

Nero - Black - Noir - Schwarz
 Cavo nero - Black cable
 Câble noir - Schwarzes Kabel



3804-46-102
 42W - 4500 lm

Bianco - White - Blanc - Weiss
 Cavo trasparente - Transparent cable
 Câble transparent - Transparentes Kabel

Rettangolare 6 luci
 Rectangular 6 lights
 Rectangulaire 6 lumières
 Rechteckig 6-flammig

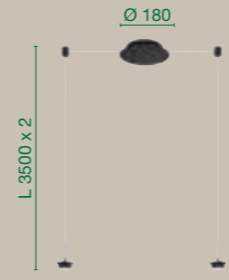

3804-42-101
 16W - 1500 lm

Nero - Black - Noir - Schwarz
 Cavo nero - Black cable
 Câble noir - Schwarzes Kabel

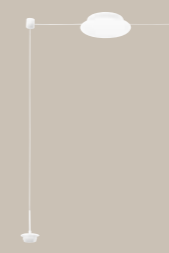

3804-42-102
 16W - 1500 lm

Bianco - White - Blanc - Weiss
 Cavo trasparente - Transparent cable
 Câble transparent - Transparentes Kabel

2 supporti per cavo inclusi
 2 supports for cable included
 2 supports pour câble inclus
 2 Kabelumenker inklusive

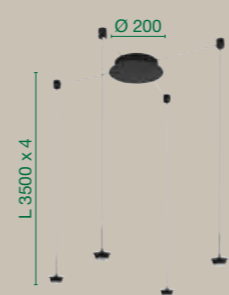

3804-44-101
 28W - 3000 lm

Nero - Black - Noir - Schwarz
 Cavo nero - Black cable
 Câble noir - Schwarzes Kabel

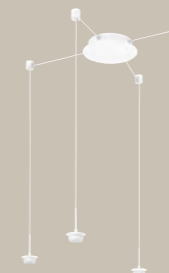

3804-44-102
 28W - 3000 lm

Bianco - White - Blanc - Weiss
 Cavo trasparente - Transparent cable
 Câble transparent - Transparentes Kabel

4 supporti per cavo inclusi
 4 supports for cable included
 4 supports pour câble inclus
 4 Kabelumenker inklusive

kit luci LED 8W

Paralume in metallo / Metal shade
Abat-jour en métal / Metallschirm



Colore paralume
Lampshade color
Couleur de l'abat-jour
Farbe des Schirms:

Esterno - External
Exterieur - Aussen

| | | | | | |
|--|--|---|--|---|---|
| <input type="checkbox"/> Bianco - White Blanc - Weiss | <input checked="" type="checkbox"/> Nero - Black Noir - Schwarz | <input type="checkbox"/> Grigio - Grey Gris - Grau | <input type="checkbox"/> Sabbia - Sand Couleur sable Sandfarben | <input type="checkbox"/> Blu avio - Aviation blue Blue Aviation Aviatikblau | <input type="checkbox"/> Rosso mattone Brick red - Rouge brique - Ziegelrot |
| <input type="checkbox"/> Bianco - White Blanc - Weiss | <input checked="" type="checkbox"/> Nero - Black Noir - Schwarz | <input type="checkbox"/> Grigio - Grey Gris - Grau | <input checked="" type="checkbox"/> Sabbia - Sand Couleur sable Sandfarben | <input type="checkbox"/> Blu avio - Aviation blue Blue Aviation Aviatikblau | <input type="checkbox"/> Rosso mattone Brick red - Rouge brique - Ziegelrot |

Interno - Internal
Intérieur - Innen



kit luci LED 8W



modular suspension

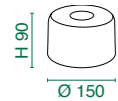

Colore paralume
Lampshade color
Couleur de l'abat-jour
Farbe des Schirms:

Esterno - External
Exterieur - Aussen

| | | | | | |
|--|--|--|---|---|---|
| <input type="checkbox"/> Bianco - White Blanc - Weiss | <input checked="" type="checkbox"/> Nero - Black Noir - Schwarz | <input type="checkbox"/> Grigio - Grey Gris - Grau | <input type="checkbox"/> Sabbia - Sand Couleur sable Sandfarben | <input type="checkbox"/> Blu avio - Aviation blue Blue Aviation Aviatikblau | <input type="checkbox"/> Rosso mattone Brick red - Rouge brique - Ziegelrot |
| <input type="checkbox"/> Bianco - White Blanc - Weiss | <input type="checkbox"/> Bianco - White Blanc - Weiss | <input type="checkbox"/> Bianco - White Blanc - Weiss | <input type="checkbox"/> Bianco - White Blanc - Weiss | <input type="checkbox"/> Bianco - White Blanc - Weiss | <input type="checkbox"/> Bianco - White Blanc - Weiss |

Interno - Internal
Intérieur - Innen



IT - Avvitare il paralume in metallo sull'illuminatore con la ghiera fornita in dotazione.

EN - Screw the metal lampshade onto the illuminator using the supplied ring.

FR - Visser le abat-jour en métal sur l'illuminateur à l'aide de l'anneau fourni.

DE - Den Metallschirm mittels des beiliegenden Schraubbrings an das Leuchtelement schrauben.

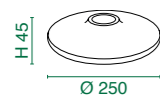

Colore paralume
Lampshade color
Couleur de l'abat-jour
Farbe des Schirms:

Esterno - External
Exterieur - Aussen

| | | | | | |
|--|--|--|---|---|---|
| <input type="checkbox"/> Bianco - White Blanc - Weiss | <input checked="" type="checkbox"/> Nero - Black Noir - Schwarz | <input type="checkbox"/> Grigio - Grey Gris - Grau | <input type="checkbox"/> Sabbia - Sand Couleur sable Sandfarben | <input type="checkbox"/> Blu avio - Aviation blue Blue Aviation Aviatikblau | <input type="checkbox"/> Rosso mattone Brick red - Rouge brique - Ziegelrot |
| <input type="checkbox"/> Bianco - White Blanc - Weiss | <input type="checkbox"/> Bianco - White Blanc - Weiss | <input type="checkbox"/> Bianco - White Blanc - Weiss | <input type="checkbox"/> Bianco - White Blanc - Weiss | <input type="checkbox"/> Bianco - White Blanc - Weiss | <input type="checkbox"/> Bianco - White Blanc - Weiss |

Interno - Internal
Intérieur - Innen



kit luci LED

kit luci LED 8W

Diffusore in vetro / Glass diffuser

Diffuseur en verre / Glasschirm

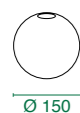

Ø 150



3804-51-369

Trasparente/cuore
Transparent/heart
Transparent/cœur
Transparent/Herz



3804-51-370

Trasparente/farfalla
Transparent/butterfly
Transparent/papillon
Transparent/Schmetterling



3804-51-371

Trasparente/pesce
Transparent/fish
Transparent/poisson
Transparent/Fisch



3804-51-372

Trasparente/goccia
Transparent/drop
Transparent/Goutte
Transparent/Tropfen

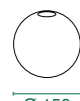

Ø 150



3804-54-241

Trasparente - Transparent



3804-54-365

Cognac



3804-54-126

Fumé - Transparent grey
Gris transparent - Grau transparent



3804-54-189

Oro - Gold
Or - Gold

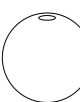

Ø 200



3804-55-241

Trasparente - Transparent



3804-55-365

Cognac



3804-55-126

Fumé - Transparent grey
Gris transparent - Grau transparent



3804-55-189

Oro - Gold
Or - Gold

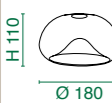

H 110
Ø 180



3804-52-241

Trasparente - Transparent



3804-52-365

Cognac

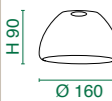

H 90
Ø 160



3804-59-365

Cognac



3804-59-126

Fumé - Transparent grey
Gris transparent - Grau transparent



H 130
Ø 150



3804-53-102

Bianco - White
Blanc - Weiss



kit luci LED 8W



IT - Avvitare il vetro sull'illuminatore.
EN - Screw the glass onto the illuminator.
FR - Visser le verre sur l'illuminateur.
DE - Das Glas an das Leuchtenelement schrauben.



kit luci LED 14W

Montatura / Frame / Monture / Aufhängung

Dimmerabile a step
Steps dimmable
Gradable
In Stufen dimmbar

2700K - 3000K - 4000K



3805-40-101
14W - 1510 lm

■ Nero - Black - Noir - Schwarz
Cavo nero - Black cable
Câble noir - Schwarzes Kabel



3805-40-102
14W - 1510 lm

□ Bianco - White - Blanc - Weiss
Cavo trasparente - Transparent cable
Câble transparent - Transparentes Kabel

Tonda 1 luce saliscendi
Round 1 light raise & fall
Ronde 1 lumière monte et baisse
Rund 1-flammig zugpendel

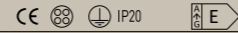

3805-41-101
14W - 1510 lm

■ Nero - Black - Noir - Schwarz
Cavo nero - Black cable
Câble noir - Schwarzes Kabel



3805-41-102
14W - 1510 lm

□ Bianco - White - Blanc - Weiss
Cavo trasparente - Transparent cable
Câble transparent - Transparentes Kabel

Tonda 1 luce
Round 1 light
Ronde 1 lumière
Rund 1-flammig

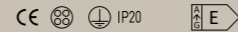

3805-47-101
42W - 4530 lm

■ Nero - Black - Noir - Schwarz
Cavo nero - Black cable
Câble noir - Schwarzes Kabel



3805-47-102
42W - 4530 lm

□ Bianco - White - Blanc - Weiss
Cavo trasparente - Transparent cable
Câble transparent - Transparentes Kabel

Tonda 3 luci Ø 500
Round 3 lights Ø 500
Ronde 3 lumières Ø 500
Rund 3-flammig Ø 500

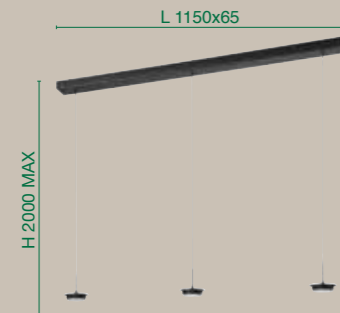

3805-48-101
42W - 4530 lm

■ Nero - Black - Noir - Schwarz
Cavo nero - Black cable
Câble noir - Schwarzes Kabel



3805-48-102
42W - 4530 lm

□ Bianco - White - Blanc - Weiss
Cavo trasparente - Transparent cable
Câble transparent - Transparentes Kabel

Rettangolare 3 luci
Rectangular 3 lights
Rectangulaire 3 lumières
Rechteckig 3-flammig



kit luci LED 14W



kit luci LED 14W

Paralume in metallo / Metal shade
Abat-jour en métal / Metallschirm

H 35
Ø 350

Colore paralume
Lampshade color
Couleur de l'abat-jour
Farbe des Schirms:

| | | | | | |
|--|--|---|---|---|---|
| 3805-56-102 | 3805-56-101 | 3805-56-288 | 3805-56-355 | 3805-56-374 | 3805-56-375 |
| <input type="checkbox"/> Bianco - White Blanc - Weiss | <input checked="" type="checkbox"/> Nero - Black Noir - Schwarz | <input type="checkbox"/> Grigio - Grey Gris - Grau | <input type="checkbox"/> Sabbia - Sand Couleur sable Sandfarben | <input type="checkbox"/> Blu avio - Aviation blue Blue Aviation Aviatikblau | <input type="checkbox"/> Rosso mattone Brick red - Rouge brique - Ziegelrot |
| <input type="checkbox"/> Bianco - White Blanc - Weiss | <input checked="" type="checkbox"/> Nero - Black Noir - Schwarz | <input type="checkbox"/> Grigio - Grey Gris - Grau | <input type="checkbox"/> Sabbia - Sand Couleur sable Sandfarben | <input type="checkbox"/> Blu avio - Aviation blue Blue Aviation Aviatikblau | <input type="checkbox"/> Rosso mattone Brick red - Rouge brique - Ziegelrot |

H 100
Ø 350

Colore paralume
Lampshade color
Couleur de l'abat-jour
Farbe des Schirms:

| | | | | | |
|--|--|--|---|---|---|
| 3805-57-102 | 3805-57-101 | 3805-57-288 | 3805-57-355 | 3805-57-374 | 3805-57-375 |
| <input type="checkbox"/> Bianco - White Blanc - Weiss | <input checked="" type="checkbox"/> Nero - Black Noir - Schwarz | <input type="checkbox"/> Grigio - Grey Gris - Grau | <input type="checkbox"/> Sabbia - Sand Couleur sable Sandfarben | <input type="checkbox"/> Blu avio - Aviation blue Blue Aviation Aviatikblau | <input type="checkbox"/> Rosso mattone Brick red - Rouge brique - Ziegelrot |
| <input type="checkbox"/> Bianco - White Blanc - Weiss | <input type="checkbox"/> Bianco - White Blanc - Weiss | <input type="checkbox"/> Bianco - White Blanc - Weiss | <input type="checkbox"/> Bianco - White Blanc - Weiss | <input type="checkbox"/> Bianco - White Blanc - Weiss | <input type="checkbox"/> Bianco - White Blanc - Weiss |

H 63
Ø 350

Colore paralume
Lampshade color
Couleur de l'abat-jour
Farbe des Schirms:

| | | | | | |
|--|--|--|---|---|---|
| 3805-58-102 | 3805-58-101 | 3805-58-288 | 3805-58-355 | 3805-58-374 | 3805-58-375 |
| <input type="checkbox"/> Bianco - White Blanc - Weiss | <input checked="" type="checkbox"/> Nero - Black Noir - Schwarz | <input type="checkbox"/> Grigio - Grey Gris - Grau | <input type="checkbox"/> Sabbia - Sand Couleur sable Sandfarben | <input type="checkbox"/> Blu avio - Aviation blue Blue Aviation Aviatikblau | <input type="checkbox"/> Rosso mattone Brick red - Rouge brique - Ziegelrot |
| <input type="checkbox"/> Bianco - White Blanc - Weiss | <input type="checkbox"/> Bianco - White Blanc - Weiss | <input type="checkbox"/> Bianco - White Blanc - Weiss | <input type="checkbox"/> Bianco - White Blanc - Weiss | <input type="checkbox"/> Bianco - White Blanc - Weiss | <input type="checkbox"/> Bianco - White Blanc - Weiss |



IT - Avvitare il paralume in metallo sull'illuminatore con la ghiera fornita in dotazione.
EN - Screw the metal lampshade onto the illuminator using the supplied ring.
FR - Visser le abat-jour en métal sur l'illuminateur à l'aide de l'anneau fourni.
DE - Den Metallschirm mittels des beiliegenden Schraubings an das Leuchtelement schrauben.

kit luci LED

kit luci LED 14W

Diffusore in vetro / Glass diffuser
Diffuseur en verre / Glasschirm

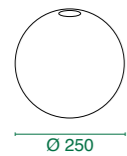

Ø 250



3805-55-241

Trasparente - Transparent



3805-55-365

Cognac



3805-55-126

Fumé - Transparent grey
Gris transparent - Grau transparent



3805-55-189

Oro - Gold
Or - Gold

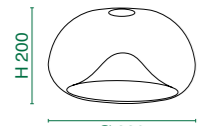

H 200

Ø 330



3805-52-241

Trasparente - Transparent



3805-52-365

Cognac

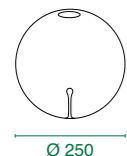

Ø 250



3805-51-372

Trasparente/goccia - Transparent/drop
Transparent/goutte - Transparent/Tropfen

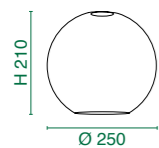

H 210

Ø 250



3805-53-102

Bianco - White
Blanc - Weiss



IT - Avvitare il vetro sull'illuminatore.
EN - Screw the glass onto the illuminator.
FR - Visser le verre sur l'illuminateur.
DE - Das Glas an das Leuchtelement schrauben.

kit luci LED

kit luci EDISON

Design s.t. Fabas Luce

Montatura in metallo, vetro borosilicato o vetro soffiato - Metal frame, borosilicate glass or blown glass
 Monture en métal, verre borosilicaté ou verre soufflé - Metall, Borsilicatglas oder geblasenes Glas



SISTEMA MODULARE E14/E27 - E14/E27 MODULAR SYSTEM
 SYSTÈME MODULAIRE E14/E27 - E14/E27 MODULARSYSTEM



Scegli la montatura
 Choose the frame
 Choisissez la monture
 Wählen Sie die Halterung



Scegli il vetro
 Choose the glass
 Choisissez le verre
 Wählen Sie das Glas



Crea la tua sospensione
 Create your suspension
 Créez votre suspension
 Erstellen Sie Ihre Pendelleuchte

IT - Un concept versatile, moderno e creativo! Scegli tra una vasta gamma di modelli di vetri in borosilicato o soffiati, combinando forme e colori diversi oppure sfruttando diverse dimensioni dello stesso modello per creare una luce unica ed esclusiva.

FR - Un concept polyvalent, moderne et créatif! Choisissez parmi une large gamme de modèles en verre borosilicaté ou soufflé, en combinant des formes et des couleurs différentes ou en utilisant différentes tailles du même modèle pour créer une lumière unique et exclusive.

EN - A versatile, modern, and creative concept! Choose from a wide range of borosilicate or blown glass models, combining different shapes and colors, or using different sizes of the same model to create a unique and exclusive light.

DE - Ein vielseitiges, modernes und kreatives Konzept! Wählen Sie aus einer breiten Palette von Modellen aus Borsilicat- oder geblasenem Glas, kombinieren Sie verschiedene Formen und Farben oder verwenden Sie verschiedene Größen desselben Modells, um eine einzigartige und exklusive Leuchte zu schaffen.

kit luci EDISON

Montatura / Frame / Monture / Halterung

Cavo non incluso – Cable not included – Câble pas inclus – Kabel nicht inklusiv

kit luci EDISON

modular suspension



3481-57-101

■ Nero - Black - Noir - Schwarz



3481-57-102

□ Bianco - White - Blanc - Weiss

Tonda 1 luce
Round 1 light
Ronde 1 lumière
Rund 1-flammig



3481-58-101

■ Nero - Black - Noir - Schwarz



3481-58-102

□ Bianco - White - Blanc - Weiss

Tonda 3 luci Ø 400
Round 3 lights Ø 400
Ronde 3 lumières Ø 400
Rund 3-flammig Ø 400



3481-51-101

■ Nero - Black - Noir - Schwarz



3481-51-102

□ Bianco - White - Blanc - Weiss

Tonda 3 luci Ø 500
Round 3 lights Ø 500
Ronde 3 lumières Ø 500
Rund 3-flammig Ø 500



3481-52-101

■ Nero - Black - Noir - Schwarz



3481-52-102

□ Bianco - White - Blanc - Weiss

Tonda 5 luci Ø 500
Round 5 lights Ø 500
Ronde 5 lumières Ø 500
Rund 5-flammig Ø 500

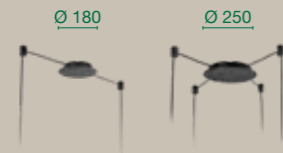

3749-52-101 3749-54-101

■ Nero - Black - Noir - Schwarz
Supporti neri - Black supports
Supports noir - Kabelumenker Schwarz



3749-52-102 3749-54-102

□ Bianco - White - Blanc - Weiss
Supporti cromati - Chrome supports
Supports chromé - Kabelumenker verchromt

2 o 4 supporti per cavo inclusi
2 or 4 supports for cable included
2 ou 4 supports pour câble inclus
2 oder 4 Kabelumenker inklusive



3481-53-101

■ Nero - Black - Noir - Schwarz



3481-53-102

□ Bianco - White - Blanc - Weiss

Rettangolare 3 luci
Rectangular 3 lights
Rectangulaire 3 lumières
Rechteckig 3-flammig



3481-55-101

■ Nero - Black - Noir - Schwarz



3481-55-102

□ Bianco - White - Blanc - Weiss

Rettangolare 5 luci
Rectangular 5 lights
Rectangulaire 5 lumières
Rechteckig 5-flammig



3481-54-101

■ Nero - Black - Noir - Schwarz



3481-54-102

□ Bianco - White - Blanc - Weiss

Rettangolare 5 luci
Rectangular 5 lights
Rectangulaire 5 lumières
Rechteckig 5-flammig



3481-56-101

■ Nero - Black - Noir - Schwarz



3481-56-102

□ Bianco - White - Blanc - Weiss

Ellittica 6 luci
Elliptical 6 lights
Elliptique 6 lumières
Elliptisch 6-flammig



3749-59-101

■ Nero - Black
Noir - Schwarz



3749-59-102

□ Bianco - White
Blanc - Weiss



3749-59-119

■ Ottone satinato - Satined brass
Laiton satiné - Messing satiniert



3749-59-138

□ Cromo - Chrome
Chromé - Verchromt

Supporto aggiuntivo per fissaggio cavo
Additional support for cable fixing
Support supplémentaire pour fixation câble
Zusätzlicher Kabelumenker

kit luci EDISON

kit luci EDISON

Diffusore in vetro / Glass diffuser
Diffuseur en verre / Glasschirm

Cavo incluso – Cable included – Câble inclus - Kabel inklusiv

kit luci EDISON

modular suspension

kit luci EDISON

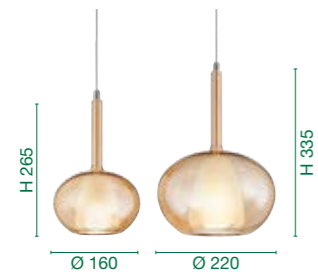

3787-59-125 3787-50-125
E14 40W E27 40W

Ambra - Amber
Ambre - Amber



3787-59-126 3787-50-126
E14 40W E27 40W

Fumé - Transparent grey
Gris transparent - Grau transparent



3787-59-241 3787-50-241
E14 40W E27 40W

Trasparente - Transparent



3787-59-189 3787-50-189
E14 40W E27 40W

Oro - Gold
Or - Gold



3787-59-107 3787-50-107
E14 40W E27 40W

Ametista - Amethyst
Améthyste - Amethyst

Cavo trasparente lunghezza 3500 mm
Transparent cable length 3500 mm
Câble transparent longueur 3500 mm
Transparentes Kabel, Länge 3500 mm

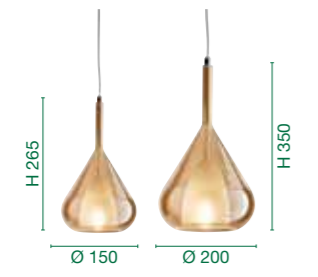
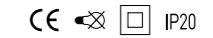

3481-59-125 3481-50-125
E14 40W E27 40W

Ambra - Amber
Ambre - Amber



3481-59-126 3481-50-126
E14 40W E27 40W

Fumé - Transparent grey
Gris transparent - Grau transparent



3481-59-140 3481-50-140
E14 40W E27 40W

Verde trasparente - Transparent green
Vert Transparent - Transparent grün



3481-59-241 3481-50-241
E14 40W E27 40W

Trasparente - Transparent
Transparent - Transparent



3481-59-244 3481-50-244
E14 40W E27 40W

Azzurro trasparente - Light blue
Bleu ciel - Azurblau

Cavo trasparente lunghezza 3500 mm
Transparent cable length 3500 mm
Câble transparent longueur 3500 mm
Transparentes Kabel, Länge 3500 mm

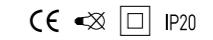

3780-52-102 3780-51-102 3780-50-102
E27 40W E27 40W E27 40W

Bianco - White - Blanc - Weiss

Cavo trasparente lunghezza 3500 mm
Transparent cable length 3500 mm
Câble transparent longueur 3500 mm
Transparentes Kabel, Länge 3500 mm

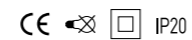

3519-59-365 3519-50-365
E27 60W

Cognac



3519-59-126 3519-50-126
E27 60W

Fumé - Transparent grey
Gris transparent - Grau transparent

Cavo nero lunghezza 3500 mm
Black cable length 3500 mm
Câble noir longueur 3500 mm
Schwarzes Kabel, Länge 3500 mm

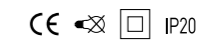

3489-50-125 3489-50-126
E27 60W E27 60W

Ambra - Amber
Ambre - Amber



3490-59-125 3490-50-125
E27 40W E27 60W

Ambra - Amber
Ambre - Amber



3490-59-126 3490-50-126
E27 40W E27 60W

Fumé - Transparent grey
Gris transparent - Grau transparent



3491-59-125 3491-50-125
E27 40W E27 60W

Ambra - Amber
Ambre - Amber



3491-59-126 3491-50-126
E27 40W E27 60W

Fumé - Transparent grey
Gris transparent - Grau transparent

Cavo nero lunghezza 3500 mm
Black cable length 3500 mm
Câble noir longueur 3500 mm
Schwarzes Kabel, Länge 3500 mm

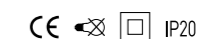



BASTA UNA PAROLA!

Lampade a controllo vocale

Gli assistenti vocali **Amazon Alexa** e **Google Home** sono ormai di uso comune nella gestione dell'illuminazione della casa e non solo. Le lampade a simbolo "Smartluce" che Fabas propone sono compatibili con l'utilizzo di alcune lampade a catalogo attraverso i comandi vocali che, interagendo attraverso la rete wi-fi, permettono di gestire la casa in modo smart e dinamico. **Cerca nel catalogo il simbolo Smartluce!**

ONE WORD IS ENOUGH!

Light voice control

The voice assistants **Amazon Alexa** and **Google Home** are commonly used in lighting home management and for many other functions. The Smartluce symbol lamps that Fabas offers are compatible through voice control which allows you to manage your home in a smart and dynamic way interacting through wi-fi networks. **Look for Smartluce symbol in the catalogue!**



SMARTLUCE INTEGRATO

Nelle pagine dove trovi il logo Smartluce integrato i prodotti possono essere già forniti con l'accessorio Smartluce. Per ordinare i prodotti con l'accessorio integrato dovrai semplicemente aggiungere in fondo al codice del prodotto scelto il suffisso "-01".

Ad esempio: qualora volessi ordinare la plafoniera BARD codice **3394-61-102**, con l'accessorio Smartluce integrato il codice diventa **3394-61-102-01**

SMARTLUCE COMPATIBILE

Per le lampade che hanno il logo Smartluce compatibile occorre indicare nell'ordine il codice della lampada e separatamente il codice dell'accessorio sotto riportato:

3572-00-001

Accessorio dimmerabile nel caso di apparecchio dimmerabile

3572-00-002

Accessorio ON/OFF nel caso di apparecchio non dimmerabile

3572-00-006

Accessorio dimmerabile solo per art. **3508-45, 3508-48, 3743-40 e 3743-46**

PER LAMPADINE CON PORTALAMPADA E27 O G9

Con lampadine E27 o G9 non dimmerabili, utilizzare l'accessorio ON/OFF **3572-00-002**.

Con lampadine E27 o G9 dimmerabili, utilizzare obbligatoriamente l'accessorio **3572-00-001**.

Il corretto funzionamento della dimmerabilità è dipendente dalla qualità dell'elettronica contenuta nella lampadina.

PERCHÈ SCEGLIERE SMARTLUCE?

Caratteristiche

1. Le nostre lampade "SMARTLUCE" sono progettate per parlare direttamente con la tua rete wi-fi attraverso l'intelligenza artificiale delle piattaforme AMAZON o GOOGLE.
2. Non hanno bisogno di accessori o gateway.
3. Non hanno bisogno di bridge o di altri accessori per controllare via assistente vocale le nostre lampade.
4. Non servono telecomandi o app per controllare le lampade.
5. Puoi controllare le nostre lampade dal tuo smartphone attraverso internet anche quando sei lontano da casa.

Funzionalità

1. Si può utilizzare normalmente l'interruttore di accensione/spengimento.
2. Si può cambiare l'intensità luminosa, accendere e spegnere attraverso la app SMARTLUCE Fabas disponibile per ANDROID/IOS.
3. Si può dimmerare, accendere e spegnere le proprie luci attraverso il sito web www.smartluce.com da qualunque parte del mondo.
4. Si può controllare le lampade dagli assistenti vocali GOOGLE HOME e ALEXA senza bisogno di Gateway.

Possibilità di utilizzo

1. Accendere una lampada o tutte le lampade.
2. Variare l'intensità della luce della lampada.
3. Programmare vari scenari, ad esempio momenti diversi della giornata.
4. Controllare gruppi di lampade.
5. Gestire la lampada Fabas insieme ad un ecosistema di altri prodotti e produttori (lampade, prese, eccetera).
6. Non servono telecomandi dedicati o app per controllare le lampade.

INTEGRATED SMARTLUCE

When you find the integrated Smartluce logo it means that the products may have the built-in accessory. To order products with the integrated accessory, just enter the product code chosen with the suffix "-01".

For example: should you wish to order the BARD ceiling lamp code **3394-61-102**, with the integrated Smartluce accessory the code becomes **3394-61-102-01**

COMPATIBLE SMARTLUCE

Should you wish to order lamps that have the compatible Smartluce logo you must indicate in the order the code number of the lamp and the code of Smartluce accessory separately by using the code below:

3572-00-001

Dimmable accessory in case of dimmable lighting

3572-00-002

ON/OFF accessory in case of non-dimmable lighting

3572-00-006

Dimmable accessory only for item **3508-45, 3508-48, 3743-40 and 3743-46**

FOR LAMPS WITH E27 OR G9 LAMP HOLDERS

With not dimmable E27 or G9 bulbs, use our accessory ON/OFF **3572-00-002**.

With dimmable E27 or G9 bulbs, it is mandatory to use our accessory **3572-00-001**.

Be aware that a correct functionality of dimming depends on electronics quality contained in the bulb.

WHY CHOOSE SMARTLUCE?

Features "Smartluce"

1. Our "SMART LUCE" lamps are engineered to speak directly with your wi-fi network through the artificial intelligence of AMAZON or GOOGLE platforms.
2. They do not need accessories or gateways.
3. They do not need bridge or other accessories to control our lamps via voice assistant.
4. No remote controls or apps are required to control the lamps.
5. You can control our lamps from your smartphone through internet even when you are away from home.

Functions

1. On/off switch installed in your house can be normally used.
2. Dimming, switch on and off the light through SMARTLUCE Fabas App available for ANDROID/ IOS.
3. Dimming, turning on and off your lights through www.smartluce.com website from anywhere in the world.
4. Control the lamp lighting from GOOGLE HOME and ALEXA voice assistants without needing a Gateway.

How to use

1. Turn on a lamp or all lamps.
2. Dimming the lamp lighting.
3. Program different scenarios, for example different moments of the day.
4. Control and manage groups of lamps.
5. Manage Fabas lamp together with an ecosystem of other products and producers (lamps, sockets, etc.).
6. No need for remote or apps to control the lamps.



spiegazione dei simboli

symbols explanation



Dimmerabile
Dimmable
Dimmable
Dimmbar



Dimmerabile a step
Step dimmable
Gradable
In Stufen dimmbar



Orientabile
Adjustable
Réglable
Schwenkbar



Ricaricabile
Rechargeable
Réglable
Wiederaufladbar



Gira e blocca
Turn&Lock



USB charger



Con interruttore
With switch
Avec interrupteur
Mit Schalter



Con doppio interruttore
With double lighting
Avec double allumage
Getrennt schaltbar



Sensore di movimento
Motion sensor
Capteur de mouvement
Bewegungssensor



Sensore ad infrarossi
Infrared sensor
Capteur à infrarouge
Infrarotsensor



Gravity sensor



Bluetooth



Accensione al tocco
Touch switch
Allumage tactile
Tastschaltung



Regolazione luce con pulsante
Push dimmer
Bouton pousoir
Tastdimmer



Con variatore
With dimmer
Avec variateur
Mit Dimmer



Regolazione al tocco
Touch dimmer
Variateur sensitif
Touchdimmer



Dimmerazione a sensore
Sensor dimming
Capteur gradateur
Sensordimmer



Temperatura colore
Light color temperature
Température de couleur de la lumière
Farbtemperatur



Materiale in plastica vegetale
Plant-based plastic material
Matière en plastique végétale
Pflanzenbasierter Kunststoff



Realizzato con una stampante 3D
Made with a 3D printer
Fabriqué avec une imprimante 3D
Hergestellt mit einem 3D-Drucker



Materiale in legno
Wooden material
Matière en bois
Holz



Materiale in ceramica
Ceramic material
Matière en céramique
Keramik



Materiale in vetro
Glass material
Matière en verre
Glas



Regolazione temperatura colore della luce
Light color temperature change
Réglage de la température de couleur de la lumière
Farbtemperatursteuerung

La dimmerazione funziona a taglio di fase: si raccomanda l'utilizzo di variatori compatibili. Alcune delle marche con prodotti compatibili sono: VARILIGHT, JUNG, BUSCH, AURORA, TCL

The dimming function works on phase cut dimmers: we recommend appropriate dimmers. Some appropriate products are manufactured by the following: VARILIGHT, JUNG, BUSCH, AURORA, TCL

La fonction de gradation fonctionne avec des variateurs à découpage de phase: nous recommandons d'utiliser des variateurs appropriés. Certains produits appropriés sont fabriqués par les sociétés suivantes: VARILIGHT, JUNG, BUSCH, AURORA, TCL

Die Dimmfunktion arbeitet sowohl mit Phasenanschnittdimmer als auch mit Phasenabschnittdimmer. Wir empfehlen geeignete Dimmer zu verwenden. Hersteller einiger geeigneter Produkte sind: VARILIGHT, JUNG, BUSCH, AURORA, TCL

INCLUSO
INCLUDED
INCLUS
INKLUSIV



LED



G9



GU10

NON INCLUSO
NOT INCLUDED
PAS INCLUS
NICHT INKLUSIV



E14



E27



GU10

IP20

Protetto contro corpi solidi maggiori di 12 mm.

Protected against solid objects greater than 12 mm.

Protégé contre les corps solides supérieur à 12 mm.

Schutz vor dem Eindringen von Stoffen mit einem Durchmesser von mehr als 12 mm.

IP40

Protetto contro corpi solidi maggiori di 1 mm.

Protected against solid objects greater than 1 mm.

Protégé contre les corps solides supérieur à 1 mm.

Schutz vor dem Eindringen von Stoffen mit einem Durchmesser von mehr als 1 mm.

IP41

Protetto contro corpi solidi maggiori di 1 mm e contro lo stillicidio.

Protected against solid objects greater than 1 mm and dripping water.

Protégé contre les corps solides supérieurs à 1 mm et contre les chutes verticales de gouttes d'eau (condensation).

Schutz vor dem Eindringen von Stoffen mit einem Durchmesser von mehr als 1 mm und vor dem Eindringen von Tropfen.

IP44

Protetto contro corpi solidi maggiori di 1 mm e contro gli spruzzi.

Protected against solid objects greater than 1 mm and splashing water.

Protégé contre les corps solides supérieur à 1 mm et de giclées d'eau.

Schutz vor dem Eindringen von Stoffen mit einem Durchmesser von mehr als 1 mm und vor dem Eindringen von Spritzwasser.



Tutti i prodotti FABAS LUCE che rientrano nell'ambito di applicazione della direttiva europea compatibilità elettromagnetica E.M.C. 2014/30/UE e successive modifiche e/o della direttiva europea bassa tensione B.T. 2014/35/UE e successive modifiche, soddisfano i requisiti richiesti e recano la marcatura "CE".

All FABAS LUCE products fall within the range of application of the European electromagnetic compatibility E.M.C. directive 2014/30/UE and subsequent amendment and/or the European low voltage directive B.T. 2014/35/UE and subsequent, meet the required specifications and bear "CE" labelling.

Tous les produits FABAS LUCE appartenant au champ d'application de la directive européenne compatibilité électromagnétique E.M.C. 2014/30/UE et modifications successives et/ou de la directive européenne basse tension B.T. 2014/35/UE et modification successive remplissent les conditions prévues et portent le marquage "CE".

Alle Produkte von FABAS LUCE, die unter das Anwendungsgebiet der europäischen Richtlinien der elektromagnetischen Kompatibilität E.M.C. 2014/30/UE und nachfolgende Änderungen und/oder der europäischen Richtlinie der Niederspannung B.T. 2014/35/UE und nachfolgende Änderung fallen, entsprechen den erforderlichen Eigenschaften und tragen das "CE" -Kennzeichen.



Lampada la cui protezione contro la scarica elettrica non si basa solo sull'isolamento di base dell'apparecchio, ma su un ulteriore sistema di sicurezza che consiste nel collegamento dei componenti conduttivi accessibili ad un conduttore di sicurezza (messa a terra) facente parte dell'impianto elettrico.

Luminaire in which protection against electrical shocks is not just based on the basic insulation but also on an additional safety precautions consisting of connecting the accessible conductive parts to a safety conductor (earth), that is included in the electrical system.

L'appareil d'éclairage dans lequel la protection contre des chocs électriques n'est pas simplement basée sur l'isolation principale mais également sur des mesures de sécurité additionnelles en consistant à relier les parties conductrices accessible à un conducteur de sûreté (la terre), celui inclus dans le système électrique.

Leuchten in denen der Schutz gegen Stromschläge nicht nur auf der grundlegenden Isolierung basiert ist, sondern auch auf einer zusätzlichen Sicherheitsvorkehrung, bestehend aus den Anschluss der berührbaren leitfähigen Teile zu einem Schutzleiter (Erde), der in elektrischem System enthalten ist.



Apparecchio omologato in classe II, con cablaggio a doppio isolamento. Durante l'installazione, tagliare il cavo di terra.

Class II certified equipment, with double insulated wiring. During installation, cut earth wire.

Appareil homologué en Classe II, avec câblage à double isolation. Pendant l'installation, couper le câble de terre.

In Klasse II zugelassene Apparate mit doppelt isolierter Verkabelung. Während der Montage schneiden sie das Erdekabel.



In caso di sostituzione della lampadina, utilizzarne una auto-protetta, che non necessita di schermo di protezione.

In case of bulb replacement, use the auto-protected one, which doesn't need any other protection glass.

Dans le cas du remplacement de l'ampoule, utiliser l'une auto-protégée, laquelle n'a pas besoin de autre verre de protection.

Sollte die Birne ersetzt werden, die selbstbeschützende Birne benutzen, die kein weiteres Schutzglas braucht.



Apparecchio in cui la protezione contro la scossa elettrica si basa sull'alimentazione a bassissima tensione di sicurezza (SELV) e in cui non si producono tensioni superiori alla stessa.

A luminaire in which protection against electric shock relies on supply at safety extra-low voltage (SELV) and in which voltages higher than those of SELV are not generated.

Un appareil d'éclairage dans lequel la protection contre la décharge électrique se fonde sur l'approvisionnement à la très-basse tension de sûreté (SELV) et dans quelles tensions plus haut que ceux de SELV ne sont pas produits.

Eine Beleuchtung, in der Schutz gegen Elektroschock auf Versorgungsmaterial an der sehr-niedrigen Spannung der Sicherheit (SELV) beruht und in in welchen Spannungen höher, als die von SELV werden nicht erzeugt.



Il simbolo indica la non idoneità degli apparecchi al montaggio diretto su superfici normalmente infiammabili. ATTENZIONE: l'apparecchio non può essere installato su superfici in legno o rivestite con tappezzeria. Se vengono installate lampadine LED o fluorescenza con potenza pari o inferiore a 20W l'apparecchio è da considerarsi IDONEO a essere installato su superfici normalmente infiammabili.

The symbol indicates that the fixture is not suitable for assembly directly on normally inflammable surfaces. WARNING: the fixture can not be fixed on wall in wood or covered by wallpaper. If they are equipped with LED or fluorescent bulbs with power equal to or less than 20W the fixture is considered SUITABLE to be installed on flammable surfaces.

Le symbole indique que cet Appareil ne doit pas être monté directement sur des surfaces normalement inflammables. ATTENTION: l'appareil ne doit pas être monté sur les surfaces revêtu de bois ou de tapisserie (surfaces normalement inflammables). S'il est équipé avec des ampoules LED ou fluorescents avec une puissance inférieure à ou égale à 20W l'appareil est considéré adapté pour être installé sur les surfaces inflammables.

Die Leuchte ist nicht dazu geeignet, direkt auf normal entflammbaren Oberflächen installiert zu werden. ACHTUNG: das gerät kann nicht auf holz- oder mit tapetenpapier belegten oberflächen montiert werden. Bei Bestückung der Leuchte mit LED- oder Fluoreszenz-Leuchtmitteln mit einer Leistung von maximal 20 Watt kann das Gerät an entflammbaren Oberflächen montiert werden.

indice per codice prodotto

item code index

| code | name | category | page | |
|------|--------------------|--------------|------------|-----|
| 2385 | FOX E27 | ceiling lamp | 242 | |
| | | wall lamp | 305 | |
| 2433 | PANDORA E27 | ceiling lamp | 234 | |
| | | wall lamp | 296 | |
| 2523 | DEDALO | wall lamp | 294 | |
| 2533 | ADE | table lamp | 398 | |
| 2642 | DEDALO IP44 | wall lamp | 321 | |
| 2653 | LUCY BIG | table lamp | 391 | |
| 2654 | GAIA BIG | table lamp | 393 | |
| 2753 | DIANA | suspension | 146 | |
| 2866 | PLAZA E27 | ceiling lamp | 240 | |
| 2867 | OSAKA E27 | ceiling lamp | 238 | |
| 2899 | VANITY | wall lamp | 303 | |
| 2907 | PROVENZA | suspension | 150 | |
| 2908 | NICE | suspension | 151 | |
| 2957 | MAGGIE | ceiling lamp | 244 | |
| | | wall lamp | 297 | |
| 2958 | HILL | ceiling lamp | 246 | |
| | | wall lamp | 298 | |
| 3113 | MILTON | wall lamp | 299 | |
| 3161 | LODGE | suspension | 168 | |
| 3177 | SLANE | wall lamp | 300 | |
| 3209 | GRAFF E27 | ceiling lamp | 232 | |
| 3215 | DINGLE | suspension | 170 | |
| 3222 | PANDORA E27 SENSOR | ceiling lamp | 236 | |
| 3239 | DUNK | suspension | 80 | |
| | | wall lamp | 282 | |
| 3249 | MOA | wall lamp | 301 | |
| 3253 | MILL | wall lamp | 276 | |
| 3257 | SIMI | table lamp | 384 | |
| 3265 | WASP | table lamp | 360 | |
| 3339 | JAP | table lamp | 386 | |
| 3357 | ARAGON E27 | suspension | 144 | |
| | | ARAGON LED | suspension | 145 |
| | | ceiling lamp | 212 | |
| 3360 | GRAVITY | table lamp | 382 | |
| 3361 | NALA | wall lamp | 314 | |
| 3383 | BADIA | suspension | 158 | |
| | | wall lamp | 291 | |
| 3386 | NEUTRA | table lamp | 372 | |
| 3394 | BARD | suspension | 94 | |
| | | ceiling lamp | 216 | |
| | | wall lamp | 268 | |
| | | table lamp | 376 | |
| 3407 | BRENTA | table lamp | 380 | |
| 3410 | ISABELLA | suspension | 76 | |
| 3414 | ADRIA | wall lamp | 302 | |
| | | table lamp | 378 | |

| code | name | category | page |
|------|-------------|--------------|------|
| 3417 | GOODNIGHT | wall lamp | 310 |
| 3431 | IGLESIAS | wall lamp | 320 |
| 3463 | VINTAGE | ceiling lamp | 214 |
| 3471 | WINDOW | wall lamp | 292 |
| 3480 | SINTESI | suspension | 124 |
| 3481 | LILA | suspension | 108 |
| | | ceiling lamp | 208 |
| 3489 | ELA | suspension | 120 |
| 3490 | MAIA | suspension | 118 |
| 3491 | SILO | suspension | 122 |
| 3496 | FIONA | suspension | 116 |
| 3506 | EMMA | wall lamp | 278 |
| 3508 | GIOTTO | suspension | 88 |
| | | ceiling lamp | 224 |
| | | wall lamp | 272 |
| 3509 | BLUMA | table lamp | 406 |
| 3511 | THALIA | table lamp | 404 |
| 3518 | GISELLA | suspension | 136 |
| | | table lamp | 367 |
| 3519 | INFINITY | suspension | 114 |
| | | table lamp | 368 |
| 3521 | MAGMA | ceiling lamp | 247 |
| | | wall lamp | 304 |
| 3523 | SUNRISE | wall lamp | 280 |
| 3527 | MARBELLA | table lamp | 400 |
| 3528 | MICOL | table lamp | 401 |
| 3531 | CORVARA | suspension | 172 |
| 3532 | CASALE | suspension | 174 |
| 3533 | DUCHESSA | suspension | 176 |
| 3534 | MARINA | suspension | 178 |
| 3535 | CRUMPLE | suspension | 180 |
| 3547 | ARABELLA | suspension | 70 |
| 3550 | IDEAL | table lamp | 358 |
| | | floor lamp | 420 |
| 3551 | REGINA | wall lamp | 274 |
| | | table lamp | 356 |
| | | floor lamp | 424 |
| 3552 | RAPALLO | wall lamp | 318 |
| 3558 | REGOLO | wall lamp | 264 |
| 3559 | LOTUS | wall lamp | 266 |
| 3563 | PANDORA LED | ceiling lamp | 237 |
| 3564 | FOX LED | ceiling lamp | 243 |
| 3565 | OSAKA LED | ceiling lamp | 239 |
| 3566 | PLAZA LED | ceiling lamp | 241 |
| 3567 | GRAFF LED | ceiling lamp | 233 |
| 3568 | LUCY | table lamp | 390 |
| 3569 | GAIA | table lamp | 392 |
| 3570 | MORGANA | table lamp | 394 |

| code | name | category | page |
|------|----------|--------------|------|
| 3571 | ROCKFORD | table lamp | 387 |
| 3576 | MILADY | table lamp | 396 |
| 3579 | ZARA | table lamp | 388 |
| 3596 | DAFNE | suspension | 130 |
| 3618 | BANNY | wall lamp | 260 |
| 3623 | APOLLO | suspension | 128 |
| 3625 | VELA | suspension | 104 |
| | | ceiling lamp | 230 |
| | | table lamp | 374 |
| | | floor lamp | 430 |
| 3626 | SYLVIE | suspension | 102 |
| 3627 | GILLIS | suspension | 138 |
| 3644 | SVEVA | table lamp | 364 |
| | | floor lamp | 434 |
| 3663 | LINUS | wall lamp | 288 |
| 3666 | SINUO | suspension | 106 |
| | | ceiling lamp | 226 |
| 3670 | HOMA | suspension | 162 |
| 3672 | PEVERO | suspension | 156 |
| | | wall lamp | 287 |
| 3673 | BRITTON | suspension | 132 |
| 3675 | PANAREA | table lamp | 362 |
| 3676 | RIBOT | suspension | 154 |
| | | wall lamp | 286 |
| 3677 | CAMP | suspension | 164 |
| | | table lamp | 370 |
| 3681 | NEXT | suspension | 86 |
| 3682 | VIKI | wall lamp | 250 |
| 3685 | PRADO | suspension | 56 |
| 3689 | DOMIZIA | suspension | 140 |
| | | wall lamp | 295 |
| | | table lamp | 352 |
| | | floor lamp | 440 |
| 3690 | LOFT | wall lamp | 284 |
| 3695 | PIERRE | suspension | 155 |
| | | table lamp | 366 |
| 3697 | CORDOBA | suspension | 152 |
| | | wall lamp | 290 |
| | | floor lamp | 436 |
| 3703 | IBLA | table lamp | 348 |
| 3706 | FASSA | suspension | 160 |
| | | ceiling lamp | 228 |
| 3707 | MARIBEL | wall lamp | 252 |
| 3708 | ALIDE | wall lamp | 254 |
| 3712 | LING | suspension | 84 |
| | | floor lamp | 438 |
| 3715 | ROSEG | wall lamp | 306 |
| 3717 | DUAL | wall lamp | 308 |

| code | name | category | page |
|----------------------------|----------|--------------------|------|
| 3720 | AGO | wall lamp | 322 |
| 3743 | PALAU | suspension | 98 |
| 3750 | LOTO | suspension | 142 |
| | | floor lamp | 432 |
| 3752 | FREDDY | table lamp | 338 |
| 3754 | MICKY | table lamp | 344 |
| 3755 | BRENA | suspension | 30 |
| | | ceiling lamp | 202 |
| | | table lamp | 342 |
| 3757 | CAROLA | suspension | 182 |
| 3758 | CONE | suspension | 184 |
| 3759 | LISA | suspension | 186 |
| 3760 | NADINE | table lamp | 402 |
| 3761 | ELEA | table lamp | 346 |
| 3762 | WENDY | table lamp | 336 |
| 3763 | WILMA | table lamp | 334 |
| 3764 | LUCILLE | suspension | 46 |
| | | | |
| 3767 | KINO | suspension | 62 |
| | | ceiling lamp | 206 |
| 3768 | LAPO | suspension | 66 |
| 3770 | ARIEL | suspension | 38 |
| | | table lamp | 340 |
| 3772 | NOA | suspension | 54 |
| 3774 | DEVA | suspension | 50 |
| 3775 | BEBA | table lamp | 354 |
| | | floor lamp | 418 |
| 3783 | VICTORIA | table lamp | 350 |
| 3786 | TRATTO | floor lamp | 414 |
| 3788 | ISY | ceiling lamp | 198 |
| 3789 | QUIRK | ceiling lamp | 194 |
| 3790 | BLIP | table lamp | 330 |
| 3792 | FLICK | table lamp | 326 |
| 3798 | CONRAD | ceiling lamp | 192 |
| 3799 | GUIA | wall lamp | 256 |
| 3800 | LUNAR | suspension | 22 |
| | | ceiling lamp | 190 |
| 3803 | YUKO | suspension | 26 |
| | | ceiling lamp | 204 |
| 3807 | FIZZ | floor lamp | 410 |
| KIT LUCI LED 8W/14W | | modular suspension | 444 |
| KIT LUCI EDISON | | modular suspension | 458 |

indice alfabetico

alphabetical index

| name | code | category | page |
|-------------|------|--------------|------|
| AGO | 3720 | wall lamp | 322 |
| ADE | 2533 | table lamp | 398 |
| ADRIA | 3414 | wall lamp | 302 |
| | | table lamp | 378 |
| ALIDE | 3708 | wall lamp | 254 |
| APOLLO | 3623 | suspension | 128 |
| ARABELLA | 3547 | suspension | 70 |
| ARAGON E27 | 3357 | suspension | 144 |
| ARAGON LED | 3357 | suspension | 145 |
| | | ceiling lamp | 212 |
| ARIEL | 3770 | suspension | 38 |
| | | table lamp | 340 |
| BADIA | 3383 | suspension | 158 |
| | | wall lamp | 291 |
| BANNY | 3618 | wall lamp | 260 |
| BARD | 3394 | suspension | 94 |
| | | ceiling lamp | 216 |
| | | wall lamp | 268 |
| | | table lamp | 376 |
| BEBA | 3775 | table lamp | 354 |
| | | floor lamp | 418 |
| BLIP | 3790 | table lamp | 330 |
| BLUMA | 3509 | table lamp | 406 |
| BRENA | 3755 | suspension | 30 |
| | | ceiling lamp | 202 |
| | | table lamp | 342 |
| BRENTA | 3407 | table lamp | 380 |
| BRITTON | 3673 | suspension | 132 |
| CAMP | 3677 | suspension | 164 |
| | | table lamp | 370 |
| CAROLA | 3757 | suspension | 182 |
| CASALE | 3532 | suspension | 174 |
| CONE | 3758 | suspension | 184 |
| CONRAD | 3798 | ceiling lamp | 192 |
| CORDOBA | 3697 | suspension | 152 |
| | | wall lamp | 290 |
| | | floor lamp | 436 |
| CORVARA | 3531 | suspension | 172 |
| CRUMPLE | 3535 | suspension | 180 |
| DAFNE | 3596 | suspension | 130 |
| DEDALO | 2523 | wall lamp | 294 |
| DEDALO IP44 | 2642 | wall lamp | 321 |
| DEVA | 3774 | suspension | 50 |
| DIANA | 2753 | suspension | 146 |
| DINGLE | 3215 | suspension | 170 |
| DOMIZIA | 3689 | suspension | 140 |
| | | wall lamp | 295 |
| | | table lamp | 352 |

| name | code | category | page |
|-----------|------|--------------|------|
| | | floor lamp | 440 |
| DUAL | 3717 | wall lamp | 308 |
| DUCHESSA | 3533 | suspension | 176 |
| DUNK | 3239 | suspension | 80 |
| | | wall lamp | 282 |
| ELA | 3489 | suspension | 120 |
| ELEA | 3761 | table lamp | 346 |
| EMMA | 3506 | wall lamp | 278 |
| FASSA | 3706 | suspension | 160 |
| | | ceiling lamp | 228 |
| FIONA | 3496 | suspension | 116 |
| FIZZ | 3807 | floor lamp | 410 |
| FLICK | 3792 | table lamp | 326 |
| FOX E27 | 2385 | ceiling lamp | 242 |
| | | wall lamp | 305 |
| FOX LED | 3564 | ceiling lamp | 243 |
| FREDDY | 3752 | table lamp | 338 |
| GAIA | 3569 | table lamp | 392 |
| GAIA BIG | 2654 | table lamp | 393 |
| GILLIS | 3627 | suspension | 138 |
| GIOTTO | 3508 | suspension | 88 |
| | | ceiling lamp | 224 |
| | | wall lamp | 272 |
| GISELLA | 3518 | suspension | 136 |
| | | table lamp | 367 |
| GOODNIGHT | 3417 | wall lamp | 310 |
| GRAFF E27 | 3209 | ceiling lamp | 232 |
| GRAFF LED | 3567 | ceiling lamp | 233 |
| GRAVITY | 3360 | table lamp | 382 |
| GUIA | 3799 | wall lamp | 256 |
| HILL | 2958 | ceiling lamp | 246 |
| | | wall lamp | 298 |
| HOMA | 3670 | suspension | 162 |
| IBLA | 3703 | table lamp | 348 |
| IDEAL | 3550 | table lamp | 358 |
| | | floor lamp | 420 |
| IGLESIAS | 3431 | wall lamp | 320 |
| INFINITY | 3519 | suspension | 114 |
| | | table lamp | 368 |
| ISABELLA | 3410 | suspension | 76 |
| ISY | 3788 | ceiling lamp | 198 |
| JAP | 3339 | table lamp | 386 |
| KINO | 3767 | suspension | 62 |
| | | ceiling lamp | 206 |
| LAPO | 3768 | suspension | 66 |
| LILA | 3481 | suspension | 108 |
| | | ceiling lamp | 208 |
| LING | 3712 | suspension | 84 |

| name | code | category | page |
|--------------------|------|--------------|------|
| | | floor lamp | 438 |
| LINUS | 3663 | wall lamp | 288 |
| LISA | 3759 | suspension | 186 |
| LODGE | 3161 | suspension | 168 |
| LOFT | 3690 | wall lamp | 284 |
| LOTO | 3750 | suspension | 142 |
| | | floor lamp | 432 |
| LOTUS | 3559 | wall lamp | 266 |
| LUCILLE | 3764 | suspension | 46 |
| LUCY | 3568 | table lamp | 390 |
| LUCY BIG | 2653 | table lamp | 391 |
| LUNAR | 3800 | suspension | 22 |
| | | ceiling lamp | 190 |
| MAGGIE | 2957 | ceiling lamp | 244 |
| | | wall lamp | 297 |
| MAGMA | 3521 | ceiling lamp | 247 |
| | | wall lamp | 304 |
| MAIA | 3490 | suspension | 118 |
| MARBELLA | 3527 | table lamp | 400 |
| MARIBEL | 3707 | wall lamp | 252 |
| MARINA | 3534 | suspension | 178 |
| MICKY | 3754 | table lamp | 344 |
| MICOL | 3528 | table lamp | 401 |
| MILADY | 3576 | table lamp | 396 |
| MILL | 3253 | wall lamp | 276 |
| MILTON | 3113 | wall lamp | 299 |
| MOA | 3249 | wall lamp | 301 |
| MORGANA | 3570 | table lamp | 394 |
| NADINE | 3760 | table lamp | 402 |
| NALA | 3361 | wall lamp | 314 |
| NEUTRA | 3386 | table lamp | 372 |
| NEXT | 3681 | suspension | 86 |
| NICE | 2908 | suspension | 151 |
| NOA | 3772 | suspension | 54 |
| OSAKA E27 | 2867 | ceiling lamp | 238 |
| OSAKA LED | 3565 | ceiling lamp | 239 |
| PALAU | 3743 | suspension | 98 |
| PANAREA | 3675 | table lamp | 362 |
| PANDORA E27 | 2433 | ceiling lamp | 234 |
| | | wall lamp | 296 |
| PANDORA E27 SENSOR | 3222 | ceiling lamp | 236 |
| PANDORA LED | 3563 | ceiling lamp | 237 |
| PEVERO | 3672 | suspension | 156 |
| | | wall lamp | 287 |
| PIERRE | 3695 | suspension | 155 |
| | | table lamp | 366 |
| PLAZA E27 | 2866 | ceiling lamp | 240 |
| PLAZA LED | 3566 | ceiling lamp | 241 |

| name | code | category | page |
|---------------------|------|--------------|------------------------|
| PRADO | 3685 | suspension | 56 |
| PROVENZA | 2907 | suspension | 150 |
| QUIRK | 3789 | ceiling lamp | 194 |
| RAPALLO | 3552 | wall lamp | 318 |
| REGINA | 3551 | wall lamp | 274 |
| | | table lamp | 356 |
| | | floor lamp | 424 |
| REGOLO | 3558 | wall lamp | 264 |
| RIBOT | 3676 | suspension | 154 |
| | | wall lamp | 286 |
| ROCKFORD | 3571 | table lamp | 387 |
| ROSEG | 3715 | wall lamp | 306 |
| SILO | 3491 | suspension | 122 |
| SIMI | 3257 | table lamp | 384 |
| SINTESI | 3480 | suspension | 124 |
| SINUO | 3666 | suspension | 106 |
| | | ceiling lamp | 226 |
| SLANE | 3177 | wall lamp | 300 |
| SUNRISE | 3523 | wall lamp | 280 |
| SVEVA | 3644 | table lamp | 364 |
| | | floor lamp | 434 |
| SYLVIE | 3626 | suspension | 102 |
| THALIA | 3511 | table lamp | 404 |
| TRATTO | 3786 | floor lamp | 414 |
| VANITY | 2899 | wall lamp | 303 |
| VELA | 3625 | suspension | 104 |
| | | ceiling lamp | 230 |
| | | table lamp | 374 |
| | | floor lamp | 430 |
| VICTORIA | 3783 | table lamp | 350 |
| VIKI | 3682 | wall lamp | 250 |
| VINTAGE | 3463 | ceiling lamp | 214 |
| WASP | 3265 | table lamp | 360 |
| WENDY | 3762 | table lamp | 336 |
| WILMA | 3763 | table lamp | 334 |
| WINDOW | 3471 | wall lamp | 292 |
| YUKO | 3803 | suspension | 26 |
| | | ceiling lamp | 204 |
| ZARA | 3579 | table lamp | 388 |
| KIT LUCI LED 8W/14W | | | modular suspension 444 |
| KIT LUCI EDISON | | | modular suspension 458 |

condizioni generali di vendita

1. Premessa

1.1) Le presenti condizioni generali di vendita costituiscono parte integrante di tutti i contratti di vendita conclusi tra l'Acquirente (indicato in calce) ed il Venditore, FABAS LUCE S.p.A., con sede in Via Luigi Talamoni 75 – 20861 – Brugherio (MB) Italia, Tel. +39039890691 Fax +39039214208, mail info@fabasluce.it, P.IVA e cod.fisc. IT 10725990153 (di seguito indicata come FABAS), qualsiasi sia la forma con la quale gli stessi ordini vengono stipulati (e-mail, PEC, fax, raccomandata).

2. Accettazione

2.1) L'ordine deve essere effettuato dall'Acquirente con uno dei mezzi di cui all'articolo 1.1.
2.2) Gli ordini si considerano accettati e la vendita perfezionata al momento in cui FABAS invia all'Acquirente la conferma scritta dei termini e condizioni specifiche di vendita.
2.3) Ai sensi dei termini della vendita sono da considerare come integrate anche le condizioni di vendita riportate nella relativa fattura emessa da FABAS.
2.4) È espressamente esclusa l'applicabilità di eventuali condizioni generali di vendita dell'Acquirente e/o di qualunque altro documento equipollente che dovesse essere emeso da quest'ultimo.
2.5) Le presenti condizioni generali hanno durata a tempo indeterminato, salvo specifico recesso di una parte da comunicarsi per iscritto con preavviso non inferiore a 6 (sei) mesi. La comunicazione di recesso non pregiudica le lavorazioni e/o gli ordini in corso o per le quali siano già stati perfezionati gli ordini, con obbligo in capo all'Acquirente alla corresponsione integrale dei corrispettivi per queste pattuiti.

3. Luogo e modalità di resa

3.1) Le forniture devono essere consegnate secondo i termini di resa INCOTERMS 2020 specificati nella offerta di FABAS e/o nella conferma d'ordine.
3.2) È onere dell'Acquirente mettere tempestivamente a disposizione del Venditore tutte le informazioni ed i dati necessari per dare esecuzione alla fornitura; eventuali ritardi da parte dell'Acquirente comporteranno automaticamente una corrispondente proroga dei termini di consegna.

4. Termini di consegna

4.1) I termini temporali di consegna riportati nell'ordine o nella fattura sono da intendersi a titolo indicativo e non perentorio; pertanto, il ritardo "non rilevante" nell'evasione dell'ordine da parte di FABAS non potrà costituire motivo di annullamento dell'ordine stesso da parte dell'Acquirente e non darà diritto a quest'ultimo di richiedere a FABAS alcun risarcimento e/o indennizzo di sorta.
4.2) Si considera non rilevante un ritardo nell'evasione dell'ordine non superiore a n. 30 giorni lavorativi.
4.3) Nel caso si verifichino cause di forza maggiore, si applicheranno le norme di cui all'art. 1218 del Codice Civile (Codice Civile - R.D. n. 262/1942) e ss cc, fermo restando che FABAS si adopererà al meglio delle sue possibilità per limitare gli effetti negativi conseguenti dalla intervenuta impossibilità della prestazione.
4.4) Sono da considerarsi "cause di forza maggiore" a titolo esemplificativo, ma non esaustivo, i seguenti eventi: fenomeni eccezionali ed avversi (sisma, alluvione, maremoto, incendio, alluvione, frana, altre calamità naturali), altri eventi esterni imprevedibili (scioperi selvaggi dei mezzi di trasporto, serrate sindacali, guerre, atti di terrorismo, provvedimenti dell'autorità amministrativa e/o giudiziaria, furti di materie prime o prodotti finiti), shortage di materiali, ritardi e/o problematiche connesse ai trasporti.
4.5) Il contratto di vendita si intenderà risolto di diritto nel caso in cui l'Acquirente non provveda al ritiro della merce presso il luogo di consegna pattuito entro 15 giorni successivi alla data concordata per la consegna, con pieno diritto per FABS di richiedere il risarcimento dei danni e delle spese.

5. Qualità della merce

5.1) FABAS garantisce che la merce consegnata è conforme alle caratteristiche prescelte dall'Acquirente; a quelle indicate nelle proprie schede tecniche e cataloghi, agli standard eventualmente prescritti dalla Legge Italiana e dell'Unione Europea attualmente vigenti, anche in materia di sicurezza.
5.2) La merce fornita da FABAS è esente da vizi o difetti che la rendano inidonea all'uso per cui è stata fabbricata ed a cui è normalmente destinata (uso indicato nel sito, nel catalogo e nelle schede tecniche), a meno che l'Acquirente non abbia espressamente ordinato merce con particolari caratteristiche extra-catalogo, non richiamate dalle schede tecniche. In tale ultima ipotesi FABAS non si assume alcuna responsabilità per quanto possa verificarsi in conseguenza dell'utilizzo di prodotti modificati su esplicita richiesta dell'Acquirente.
5.3) FABAS non effettua vendite su campione o su tipo campione. I campioni eventualmente forniti da FABAS o richiesti dall'Acquirente non comportano per FABAS le garanzie qualitative ritualmente previste dalla Legge per prodotti venduti sul mercato e gli obblighi indicati al seguente art. 6.
5.4) La merce viene venduta e consegnata in imballaggi conformi alla Legge.
5.5) FABAS non assume alcuna responsabilità sul mantenimento delle caratteristiche qualitative del prodotto fornito qualora lo stesso, dopo la consegna, sia stato manipolato e/o trasformato dall'Acquirente senza che quest'ultimo abbia preventivamente consultato FABAS e richiesto la sua autorizzazione ad intervenire. In assenza di esplicita autorizzazione di FABAS, in caso di intervento dell'Acquirente, quest'ultimo perderà ogni diritto alla garanzia.

6. Reclami e diritti dell'Acquirente

6.1) Nel caso in cui si verificasse un vizio o difformità qualitativa tra il prodotto consegnato e quello preventivamente ordinato, l'Acquirente dovrà darne immediata comunicazione a FABAS denunciando ai sensi della normativa vigente in forma scritta, entro 8 giorni di calendario dal ricevimento della merce o dalla scoperta del fatto (per mezzo di e-mail o fax al n +390392142208, o e-mail all'indirizzo info@fabasluce.it) i vizi di non conformità rispetto alle caratteristiche tecniche indicate da FABAS. La garanzia è fornita per un periodo di 24 (ventiquattro) mesi decorrenti dalla data di spedizione dei prodotti, fatto salvo il caso che nel catalogo prodotti di FABAS non siano indicati termini di validità di garanzia differenti. In caso di reclamo, l'Acquirente dovrà in ogni caso astenersi dall'utilizzare il prodotto contestato, che dovrà essere idoneamente conservato onde consentire a FABAS di poter eseguire tutti i controlli e analisi opportune sulla merce contestata. Ogni denuncia da parte dell'Acquirente di vizi, difetti o difformità dovrà essere accompagnata e provata, a pena di inefficacia, da documentazione fotografica o da equipollente modalità riproduttiva, che ne certifichi la sussistenza.

6.2) In caso di fondatezza del reclamo FABAS provvederà, in primo luogo, a riparare a proprie spese il prodotto risultato non conforme o difettoso ovvero, a rifonderne il prezzo,

1. Premise

1.1) The following general sales conditions are essential part of all sale contracts concluded between the Purchaser and the Seller, FABAS LUCE S.p.A., located in Via Luigi Talamoni 75 - 20861 - Brugherio (MB) Italy - Pho. +39039890691 Fax +390392142208, mail: info@fabasluce.it, VAT N. IT10725990153 (hereinafter referred to as FABAS), no matter which procedure the sale orders are stipulated between the Parties (e-mail, registered e-mail , fax, registered letter).
2. Acceptance
2.1) Orders must be placed by the Purchaser through one of the procedures listed in 1.1.
2.2) Orders will be deemed accepted and the sale executed when FABAS will send the written confirmation for the specific order to the customer.
2.3) The Parties agree to integrate the terms of sale also with the conditions issued by FABAS on any sale invoice.
2.4) applicability of any general conditions of sale of the Purchaser and / or any other equivalent document that may be issued by the latter is expressly excluded.
2.5) These general conditions have an indefinite duration; each party is in any case entitled to freely withdraw from these general conditions by means of written notice to be sent at least 6 (six) months in advance. Such withdrawal does not affect all work and/or in progress or for which orders have already been completed, with the Purchaser being obliged to pay in full the consideration agreed upon.

7. Prezzi e pagamenti

7.1) I prezzi di vendita dei prodotti FABAS sono quelli risultanti dalle fatture pro-forma o dalle fatture definitive di acquisto.
7.2) Le modalità ed i termini di pagamento sono quelli pattuiti e riportati nella fattura definitiva, o nella pro-forma, o nei DDT emessi da FABAS.
7.3) Sarà facoltà del Venditore modificare i corrispettivi pattuiti, anche in corso di esecuzione, in caso di aumento dei costi delle materie prime superiore al 10%. In tutti i predetti casi il Venditore provvederà a darne notizia all'Acquirente, indicando le ragioni e l'adeguamento del corrispettivo, osservato un congruo preavviso.

8. Mancato o ritardato pagamento

8.1) In caso di mancato o ritardato pagamento anche parziale, rispetto alla scadenza pattuita ed indicata in fattura verranno applicate le norme di cui al D.Lgs. 09.10.2002 n.231, ivi comprese quelle attinenti la decorrenza degli interessi ed il saggio degli stessi.
8.2) Eventuali ritardi o inadempimenti nel pagamento del corrispettivo, anche per una sola fattura, legittimeranno il Venditore a sospendere ogni attività. Dal momento in cui il corrispettivo precedentemente non pagato nei termini concordati giunga nella disponibilità del Venditore, questi riprenderà le attività di produzione/fornitura in un tempo ragionevolmente compatibile con il proprio ciclo produttivo. Il periodo di tempo in cui le forniture sono state oggetto di sospensione sarà automaticamente aggiunto ai termini di consegna concordati, o a quelli normalmente attesi in relazione alle lavorazioni concordate.

9. Responsabilità di FABAS

9.1) In nessun caso FABAS sarà responsabile per danni indiretti, perdite di profitti/affari/ opportunità o perdita di avviamento.

10. Trasferimento di rischio e proprietà

10.1) Il rischio di perdita o danneggiamento della merce fornita sarà trasferito in capo all'Acquirente alla stregua dei termini di resa Incoterms 2020 pattuiti.
10.2) La proprietà della fornitura sarà trasferita all'Acquirente successivamente al pagamento integrale da parte di quest'ultimo del corrispettivo pattuito.

11. Proprietà intellettuale, riservatezza e privacy

11.1) Ciascuna parte si obbliga a mantenere la più totale riservatezza riguardo ad ogni informazione, dato (anche tecnico), documento, processo di produzione, progetto, know-how, disegno, software, strategia commerciale, prezzo, cliente e più in generale attività dell'altra parte (le "Informazioni Riservate"), dei quali sia venuta o verrà a conoscenza in fase di trattativa precontrattuale o durante l'esecuzione del presente rapporto contrattuale.
11.2) Le parti potranno utilizzare le Informazioni Riservate al solo ed unico fine di correttamente adempiere alle obbligazioni previste dal presente rapporto contrattuale. In particolare, ed a titolo esemplificativo, le parti non potranno diffondere né comunicare a terzi le Informazioni Riservate, a meno che non sia previsto da disposizioni di legge, regolamentari e/o da richieste di autorità pubbliche e/o giudiziarie.
11.3) Le parti si impegnano ad ogni modo a far osservare i medesimi obblighi di riservatezza ai dipendenti/collaboratori/funzionari propri che siano venuti o verranno a conoscenza delle Informazioni Riservate, garantendone l'adempimento anche quale promessa del fatto di terzo ai sensi dell'articolo 1381 cod. civ.
11.4) Ciascuna parte si obbliga, a semplice richiesta dell'altra Parte, a riconsegnare tutti i documenti o altro materiale contenente le Informazioni Riservate, in qualsiasi forma posseduti, ovvero a distruggere e certificare la distruzione di detto materiale, nonché a cancellare o distruggere qualsiasi copia o registrazione delle Informazioni Riservate effettuata su computer o attraverso qualsiasi altro strumento e supporto informatico.
11.5) I diritti di privativa industriale e/o intellettuale, compreso il relativo know-how, nonché ogni risultato suscettibile di formare oggetto di diritti di privativa, elaborati, forniti, inglobati/ricompresi nella merce, o comunque comunicati da FABAS all'Acquirente, sono e restano di esclusiva proprietà di FABAS.
11.6) Le Parti si danno atto di essersi reciprocamente informate ed autorizzate al trattamento dei dati personali, ai sensi del D. Lgs. n. 196/2003 (e s.m.i.) e del Regolamento UE 679/2016 (e s.m.i.), dichiarandosi all'uopo edotte dei diritti conferiti dalle predette disposizioni di legge, in relazione agli adempimenti connessi all'esecuzione del presente rapporto contrattuale.

12. Legge applicabile e Foro competente

12.1) Le presenti condizioni generali ed i singoli rapporti di fornitura sono disciplinati dalla legge italiana. È esclusa l'applicazione della "Convenzione di Vienna del 1980 sulla vendita internazionale di merci" e di altre convenzioni, regolamenti o norme di diritto internazionale relative alla vendita di merci e/o alla fornitura (anche di servizi).
12.2) Per tutte le controversie derivanti dall'interpretazione, o dall'esecuzione del presente rapporto contrattuale viene pattuita la competenza esclusiva del Foro di Monza (Italia).

general sales conditions

1. Premise

1.1) The following general sales conditions are essential part of all sale contracts concluded between the Purchaser and the Seller, FABAS LUCE S.p.A., located in Via Luigi Talamoni 75 - 20861 - Brugherio (MB) Italy - Pho. +39039890691 Fax +390392142208, mail: info@fabasluce.it, VAT N. IT10725990153 (hereinafter referred to as FABAS), no matter which procedure the sale orders are stipulated between the Parties (e-mail, registered e-mail , fax, registered letter).
2. Acceptance
2.1) Orders must be placed by the Purchaser through one of the procedures listed in 1.1.
2.2) Orders will be deemed accepted and the sale executed when FABAS will send the written confirmation for the specific order to the customer.
2.3) The Parties agree to integrate the terms of sale also with the conditions issued by FABAS on any sale invoice.
2.4) applicability of any general conditions of sale of the Purchaser and / or any other equivalent document that may be issued by the latter is expressly excluded.
2.5) These general conditions have an indefinite duration; each party is in any case entitled to freely withdraw from these general conditions by means of written notice to be sent at least 6 (six) months in advance. Such withdrawal does not affect all work and/or in progress or for which orders have already been completed, with the Purchaser being obliged to pay in full the consideration agreed upon.

2. Acceptance

2.1) Orders must be placed by the Purchaser through one of the procedures listed in 1.1.
2.2) Orders will be deemed accepted and the sale executed when FABAS will send the written confirmation for the specific order to the customer.
2.3) The Parties agree to integrate the terms of sale also with the conditions issued by FABAS on any sale invoice.
2.4) applicability of any general conditions of sale of the Purchaser and / or any other equivalent document that may be issued by the latter is expressly excluded.
2.5) These general conditions have an indefinite duration; each party is in any case entitled to freely withdraw from these general conditions by means of written notice to be sent at least 6 (six) months in advance. Such withdrawal does not affect all work and/or in progress or for which orders have already been completed, with the Purchaser being obliged to pay in full the consideration agreed upon.

3. Delivery place and terms

3.1) The goods must be delivered according to the INCOTERMS 2020 specified in the offer sent by FABAS and/or in the order confirmation.
3.2) It is the Purchaser's responsibility to promptly make available to the Seller all the information and data necessary to execute the supply; any delays on the part of the Purchaser will automatically result in a corresponding extension of the delivery terms

4. Delivery

4.1) Delivery time agreed for the products on the sale orders and issued on the final invoices must be considered as a reference but not as a rigid indication; therefore a "not relevant" delay on the delivery of the ordered products, made by FABAS, must not be considered by the Purchaser as a breach of the contract. Therefore in this last case the Purchaser will not have any right to claim any compensation and/or indemnity to FABAS.
4.2) On the basis of the present terms of sale it is deemed "not relevant" a delay not exceeding n. 30 working days.
4.3) Where force majeure events occur, the rules of Article 1218 of the Italian Civil Code (Codice Civile – R.D. n. 262/1942) must be applied, nonetheless DGA will make all efforts to limit the negative effects resulting from the supervening impossibility of performance.
4.4) The following events are deemed "force majeure events" as an example (but not as an exhaustive list): adverse and exceptional phenomena (earthquake, flood, tsunami, fire, flood, landslide and other natural disasters), other unforeseeable external events (wildcat strikes of transport services, strikes or lockouts, war, act of terrorism, provisions of administrative and judicial authorities, theft of raw materials or finished products, exaggerated increases in the prices of raw materials), shortage of materials, delays and / or problems related to transport
4.5) Any sale agreement shall be deemed terminated in the event that the Purchaser fails to pick up the goods at the agreed place of delivery within 15 days after the agreed delivery date. In this case FABAS is entitled to claim compensation for damages and costs.

5. Goods quality

5.1) FABAS ensures that the delivered products fully comply with the features selected by the Purchaser; with the characteristics indicated in the technical data sheets and catalogues and with the standards prescribed by Italian and European Union Laws currently in force, including all the mandatory safety regulations.
5.2) The goods supplied by FABAS are free from defects that make such goods unfit or unable for the use for which they were manufactured or which is normally intended to (uses indicated on the website, in the catalogues and in the technical data sheets), unless the Purchaser has expressly ordered goods with special features, not included in the sale catalogues or not mentioned by the technical specifications. In this last case FABAS does not assume any liability for what may occur as a result of the modifications required on the products by the Purchaser.
5.3) FABAS does not process sales of samples. Samples provided by FABAS or requested by the Purchaser shall not oblige FABAS to provide the same standard quality warranty prescribed by the Law and by the following art. 6 for products regularly sold on the market.
5.4) The goods are packaged in accordance with the applicable laws.
5.5) FABAS does not assume any responsibility for the maintenance of products quality, in case the same products after the delivery have been modified and/or transformed by the Purchaser without the latter's prior consultation and authorization of FABAS. In absence of explicit authorization of FABAS, the Purchaser will lose all warranty rights.

6) Complaints and rights of the Purchaser

6.1) In case of defects of the delivered products, the Purchaser shall immediately send a prior and written notice of complaint to FABAS, in accordance with the Laws, within 8 days after the receipt of the goods or the acknowledgement of the defect (through registered letter, fax to +390392142208, or e-mail at info@fabasluce.it) mentioning any single element of non-compliance with the technical specifications of FABAS catalogues. Warranty is provided for a period of 24 (twentyfour) months starting from the shipment date, unless different guarantee terms are indicated in the FABAS product catalogue. In the event of a complaint, the Purchaser shall in any case refrain from using the disputed product, which must be properly stored in order to allow FABAS to be able to perform all appropriate checks and analyses on the disputed goods. Any complaint by the Purchaser of flaws, defects or discrepancies must be accompanied and proven, under penalty of ineffectiveness, by photographic documentation or an equivalent reproductive method, which certifies their existence.
6.2) In case of confirmed defects, FABAS will first repair at its own expenses the defective item and then, in case the repair is not possible, will refund the cost of the purchase. In any case, it is understood that the guarantee only includes the supply by FABAS of materials necessary for the repair works; any further activity (including interventions and on-site installation) will therefore be the sole responsibility and expense of the Buyer.
6.3) No compensation claim for any direct and/or indirect damage may be made by the Purchaser against FABAS, in case FABAS' conduct complies with the above mentioned art. 6.1, 6.2.

1. Prices and payments

7.1) FABAS products sale prices are specifically indicated in the pro-forma invoices and/ or in the final sales invoices.
7.2) Final conditions and terms of payment are the ones agreed and issued in the final invoices, or in the pro-forma invoices, or in the Delivery Note issued by FABAS.
7.3) The Seller will be entitled to modify the agreed fees, even during execution of the contract, in the event of an increase in the cost of raw materials exceeding 10%. In all the aforementioned cases, the Seller will notify the Purchaser, indicating the reasons and the adjustment of the consideration, subject to adequate notice.

8. Failed or delayed payment

8.1) In case of failed, delayed or partial payments with respect to the agreed deadline and indicated on the invoice., the rules referred to in Legislative Decree 09.10.2002 n. 231 will be applied, including those relating to the effective date of interest and interest rates .
8.2) Any delays or non-fulfillment in payment of the consideration, even for a single invoice, will entitle the Seller to suspend all activities. As soon as the consideration previously not paid within the agreed terms reaches the Seller's availability, the Seller will resume production / supply activities in a time reasonably compatible with its production cycle. The period of time in which the supplies have been suspended will be automatically added to the agreed delivery terms, or to those normally expected in relation to the agreed processes.

9. FABAS liability

9.1) In no event will FABAS be liable for indirect damages, loss of profits / business / opportunity or loss of goodwill.

10.Transfer of risk and ownership

10.1) Risk of loss or damage to the goods supplied will be transferred to the Purchaser in accordance with the Incoterms 2020 agreed upon.
10.2) Ownership of the goods will be transferred to the Purchaser after full payment of the contract price.

11. Intellectual property, confidentiality and privacy

11.1) Each party undertakes to maintain complete confidentiality regarding any information, data (including technical), document, production process, project, know-how, design, software, commercial strategy, price, customer and more generally activities of the other party (the "Confidential Information"), of which it has come or will become aware of during the pre-contractual negotiation phase or during the execution of this contractual relationship.
11.2) The parties may use the Confidential Information for the sole purpose of correctly fulfilling the obligations set out in this contractual relationship. In particular, and by way of example, the parties may not disseminate or communicate Confidential Information to third parties, unless required by law, regulations and / or requests from public and / or judicial authorities.
11.3) The parties undertake in any case to ensure compliance with the same confidentiality obligations by their employees / collaborators / officials who have come to or will become aware of the Confidential Information, guaranteeing their fulfillment also as a promise of the fact of a third party pursuant to article 1381 of the Italian Civil Code.
11.4) Each party undertakes, at the simple request of the other Party, to return all documents or other material containing the Confidential Information, in any form it possesses, or to destroy and certify the destruction of said material, as well as to cancel or destroy any copies or recording of Confidential Information carried out on a computer or through any other computer tool and support.
11.5) Industrial and / or intellectual property rights, including the related know-how, as well as any result likely to be the subject of proprietary rights, processed, supplied, incorporated / included in the goods, or in any case communicated by FABAS to the Purchaser, are and remain the exclusive property of FABAS.
11.6) The Parties acknowledge that they have mutually informed and authorized the processing of personal data, pursuant to Legislative Decree no. 196/2003 (as amended) and EU Regulation 679/2016 (as amended), and they declare themselves for this purpose to be aware of the rights conferred by the aforementioned provisions of law, in relation to the obligations related to the execution of this contractual relationship.

12. Applicable law and jurisdiction

12.1) These general conditions and the specific supply relationships are governed by Italian law. The application of the "Vienna Convention of 1980 on the International Sale of Goods" and other conventions, regulations or rules of international law relating to the sale of goods and / or the supply (also of services) is excluded.
12.2) For all disputes arising from the interpretation or execution of this contractual relationship, the parties submit to the exclusive jurisdiction of the Court of Monza (Italy).

Allgemeine Verkaufsbedingungen

1. Vorwort

1.1) Diese allgemeinen Verkaufsbedingungen sind Teil aller zwischen dem Käufer (unten angegeben) und dem Verkäufer, FABAS LUCE S.p.A., mit Sitz in Via Luigi Talamoni 75 - 20861 - Brugherio (MB) Italia, Tel. +39039890691 Fax +39039214208, E-Mail info@fabasluce.it - St.-Nr. und USt.-IdNr. IT 10725990153 (folgend FABAS) geschlossenen Kaufverträge, unabhängig von der Auftragsart (E-Mail, PEC, Fax, Einschreiben).

2. Vertragsabschluss

2.1) Die Bestellung muss vom Käufer auf eine der in Artikel 1.1 genannten Arten aufgegeben werden.

2.2) Die Bestellung gilt als angenommen und der Verkauf als abgeschlossen, sobald FABAS dem Käufer eine schriftliche Bestätigung der spezifischen Verkaufsbedingungen übermittelt.

2.3) Die in der Rechnung von FABAS aufgeführten Bestimmungen gelten ebenfalls als Bestandteil der Verkaufsbedingungen.

2.4) Die Geltung allgemeiner Verkaufsbedingungen des Käufers und/oder anderer gleichwertiger Dokumente des Käufers wird ausdrücklich ausgeschlossen.

2.5) Die vorliegenden allgemeinen Verkaufsbedingungen sind unbefristet gültig, es sei denn, eine Vertragspartei kündigt sie ausdrücklich und schriftlich mit einer Frist von mindestens 6 (sechs) Monaten. Die Mitteilung des Rücktritts berührt nicht die laufenden oder bereits abgeschlossenen Arbeiten und/oder Aufträge, wobei der Käufer zur vollständigen Zahlung der vereinbarten Leistung verpflichtet ist.

3. Lieferung

3.1) Die Lieferung hat gemäß den im Angebot von FABAS und/oder in der Auftragsbestätigung angegebenen Lieferbedingungen INCOTERMS 2020 zu erfolgen.

3.2) Es liegt in der Verantwortung des Käufers, dem Verkäufer rechtzeitig alle für die Ausführung der Lieferung erforderlichen Informationen und Daten zur Verfügung zu stellen; etwaige Verzögerungen seitens des Käufers führen automatisch zu einer entsprechenden Verlängerung der Lieferfristen.

4. Lieferfristen

4.1) Die in der Bestellung oder in der Rechnung angegebenen Lieferfristen sind indikativ und nicht bindend; daher kann eine "unbedeutende" Verzögerung bei der Ausführung des Auftrags durch FABAS kein Grund für die Stonierung der Bestellung durch den Käufer sein und berechtigt diesen nicht, von FABAS eine Entschädigung und/oder einen Schadenersatz zu verlangen.

4.2) Als unbedeutend wird eine Verzögerung bei der Ausführung des Auftrags von nicht mehr als 30 Arbeitstagen angesehen.

4.3) Im Falle höherer Gewalt finden die Bestimmungen des Art. 1218 des italienischen Bürgerlichen Gesetzbuches (Codice Civile - R.D. n. 262/1942) und ff. Anwendung. Dabei gilt, dass FABAS sich bemüht, die negativen Auswirkungen, die sich aus der vorübergehenden Nichterfüllung ergeben, zu begrenzen.

4.4) Als "höhere Gewalt" gelten beispielsweise: außergewöhnliche und widrige Ereignisse (Erdbeben, Überschwemmung, Tsunamis, Brand, Erdbeben, andere Naturkatastrophen), andere unvorhersehbare äußere Ereignisse (Streik der Transportunternehmen, gewerkschaftliche Streiks, Kriege, Terroranschläge, behördliche und/oder gerichtliche Maßnahmen, Diebstahl von Rohstoffen oder Fertigprodukten), Materialmangel, Verzögerungen und/oder Probleme im Zusammenhang mit dem Transport.

4.5) Der Kaufvertrag gilt rechtlich als aufgelöst, wenn der Käufer die Waren nicht innerhalb von 15 Tagen nach dem festgelegten Lieferdatum am vereinbarten Lieferort abholt, wobei FABAS berechtigt ist, Schadenersatz und Kostenerstattung zu fordern.

5. Warenqualität

5.1) FABAS garantiert, dass die gelieferte Ware den vom Käufer gewünschten Eigenschaften und den in den technischen Datenblättern und Katalogen angegebenen Merkmalen sowie den vom italienischen und europäischen Recht vorgeschriebenen Normen, einschließlich der Sicherheitsnormen, entspricht.

5.2) Die von FABAS gelieferten Waren sind frei von Mängeln oder Beschädigungen, die sie für den vorgesehenen Einsatzzweck ungeeignet machen (der Einsatzzweck ist auf der Website, im Katalog und in den technischen Datenblättern angegeben), es sei denn, der Käufer hat ausdrücklich Waren mit besonderen katalogexternen Eigenschaften bestellt, die nicht in den technischen Datenblättern aufgeführt sind. In letzterem Fall übernimmt FABAS keine Verantwortung für Schäden, die sich aus der Verwendung von auf ausdrücklichen Wunsch des Käufers veränderten Produkten ergeben können.

5.3) FABAS verkauft keine Muster oder musterähnliche Produkte. Die von FABAS gelieferten oder vom Käufer angeforderten Muster implizieren für FABAS nicht die gesetzlich vorgesehenen Qualitätsgarantien für auf dem Markt verkaufte Produkte und die in Artikel 6 unten genannten Verpflichtungen.

5.4) Die Waren werden in gesetzlich vorgeschriebener Verpackung verkauft und geliefert.

5.5) FABAS übernimmt keine Verantwortung für die Aufrechterhaltung der Qualitätseigenschaften des gelieferten Produkts, wenn dieses nach der Lieferung durch den Käufer verändert und/oder umgebaut wurde, ohne dass dieser zuvor FABAS um eine Genehmigung gefragt hat. Ohne ausdrückliche Genehmigung durch FABAS verliert der Käufer bei einem solchen Fall jegliches Recht auf Garantie.

6) Mängelansprüche und Rechte des Käufers

6.1) Im Falle eines Mangels oder eines Qualitätsunterschieds zwischen dem gelieferten und dem zuvor bestellten Produkt muss der Käufer FABAS unverzüglich, innerhalb von 8 Kalendertagen nach Erhalt der Ware oder nach Feststellung des Mangels schriftlich (per Fax an Nr. +390392142208 oder per E-Mail an info@fabasluce.it) über die Nichtübereinstimmung in Bezug auf die von FABAS angegebenen technischen Merkmale informieren. Die Garantie wird für einen Zeitraum von 24 (vierundzwanzig) Monaten ab dem Versanddatum der Produkte gewährt, es sei denn, im Produktkatalog von FABAS sind andere Garantiebedingungen angegeben. Bei einer Reklamation hat der Käufer das beanstandete Produkt nicht zu benutzen und es ordnungsgemäß zu lagern, damit FABAS alle angemessenen Kontrollen und Analysen an der beanstandeten Ware durchführen kann. Jede Beanstandung von Fehlern, Mängeln oder Nichtkonformitäten durch den Käufer muss zusammen mit einem fotografischen Nachweis oder einem gleichwertigen Nachweis, der das Vorhandensein dieser Mängel bestätigt, eingereicht werden, da sonst die Reklamation unwirksam ist.

6.2) Bei berechtigter Reklamation repariert FABAS zunächst auf eigene Kosten das beanstandete Produkt oder erstattet den Preis zurück, falls eine entsprechende Reparatur nicht möglich ist. Es wird in jedem Fall davon ausgegangen, dass die Garantie ausschließlich der Lieferung von Material für die Reparatur durch FABAS umfasst; jede weitere Maßnahme

(einschließlich Eingriffe und Installation vor Ort) geht daher ausschließlich auf Kosten des Käufers.

6.3) In den in den Artikeln 6.1, 6.2 genannten Fällen kann der Käufer keinen Anspruch auf Ersatz von direkten und/oder indirekten Schäden gegenüber FABAS geltend machen, auch wenn die Reklamation berechtigt ist.

6.4) Eine Reklamation gibt dem Käufer nicht das Recht, den Vertrag sofort und einseitig zu kündigen oder die Zahlung des Produkts ganz oder teilweise zu unterlassen.

6.5) Der Artikel 6 regelt die alleinigen Gewährleistungsverpflichtungen des Verkäufers und die ausschließlichen Rechtsmittel des Käufers bei Ansprüchen wegen Mängeln an den gelieferten Produkten.

7. Preise und Zahlungsbedingungen

7.1) Die Verkaufspreise der Produkte von FABAS ergeben sich aus den Proformarechnungen oder Schlussrechnungen.

7.2) Es gelten die vereinbarten und in der Schluss- oder Proformarechnung oder in den Lieferscheinen von FABAS ausgewiesenen Zahlungsbedingungen.

7.3) Bei einer Erhöhung der Rohstoffkosten um mehr als 10% hat der Verkäufer das Recht, auch während der Ausführung die vereinbarten Preise zu ändern. In allen vorgenannten Fällen wird der Verkäufer den Käufer unter Angabe der Gründe und unter Einhaltung einer angemessenen Frist über die Anpassung der Gegenleistung informieren.

8. Nichtbezahlung oder Zahlungsverzug

8.1) Im Falle einer Nichtzahlung oder eines auch nur teilweisen Zahlungsverzugs in Bezug auf das vereinbarte und in der Rechnung angegebene Fälligkeitsdatum finden die Bestimmungen des Gesetzesdekrets Nr. 231 vom 09.10.2002 Anwendung, einschließlich der Regelungen bezüglich des Eintritts von Zinsen und deren Höhe.

8.2) Jede Verzögerung oder Nichtzahlung des Betrags, auch bei einer einzigen Rechnung, berechtigt den Verkäufer alle Tätigkeiten einzustellen. Sobald der bis dahin unbezahlte Betrag innerhalb der vereinbarten Fristen dem Verkäufer zukommt, nimmt dieser die Produktion/Lieferung in einer mit seinem Produktionszyklus vernünftigerweise zu vereinbarenden Zeit wieder auf. Die Lieferfristen werden automatisch um die Dauer der Lieferunterbrechung bzw. um die normalerweise im Zusammenhang mit den vereinbarten Arbeiten zu erwartenden Fristen verlängert.

9. Haftung von FABAS

9.1) FABAS haftet keinesfalls für indirekte Schäden, Gewinn-/Geschäfts-/Opportunitätsverluste oder Verlust des Firmenwerts.

10. Gefahrenübergang und Eigentum

10.1) Alle Risiken für den Verlust oder die Beschädigung der gelieferten Waren werden gemäß den vereinbarten Lieferbedingungen Incoterms 2020 auf den Käufer übertragen.

10.2) Der Käufer wird nach vollständiger Bezahlung der vereinbarten Gegenleistung Eigentümer der Lieferung.

11. Geistiges Eigentum, Vertraulichkeit und Datenschutz

11.1) Alle Beteiligten verpflichten sich, sämtliche Informationen, Daten (einschließlich technischer Daten), Unterlagen, Produktionsverfahren, Projekte, Know-how, Entwürfe, Software, Geschäftsstrategien, Preise, Kunden und allgemeiner die Tätigkeit des anderen Beteiligten (die "vertraulichen Informationen"), von denen sie im Rahmen der vorvertraglichen Verhandlungen oder der Durchführung dieses Vertragsverhältnisses Kenntnis erlangt haben oder erlangen werden, absolut vertraulich zu behandeln.

11.2) Die Vertragsparteien dürfen die vertraulichen Informationen einzig und allein zur ordnungsgemäßen Erfüllung ihrer Verpflichtungen aus diesem Vertragsverhältnis verwenden. Vertrauliche Informationen dürfen nicht an Dritte weitergegeben werden, es sei denn, dies ist aufgrund von Gesetzen, Vorschriften und/oder Aufforderungen von öffentlichen und/oder gerichtlichen Behörden erforderlich.

11.3) Die Vertragsparteien verpflichten sich in jedem Fall, dafür zu sorgen, dass die gleichen Vertraulichkeitsverpflichtungen von ihren eigenen Angestellten/Mitarbeitern/Beamten eingehalten werden, wobei sie deren Erfüllung auch gegenüber Dritten gemäß Artikel 1381 des italienischen Zivilgesetzbuches garantieren.

11.4) Jede Partei verpflichtet sich, auf einfaches Verlangen der anderen Partei alle Dokumente oder sonstiges Material, das vertrauliche Informationen enthält, in welcher Form auch immer, zurückzugeben oder zu vernichten, sowie alle Kopien oder Aufzeichnungen von vertraulichen Informationen, die auf einem Computer, einem sonstigen Medium oder durch einer Computerunterstützung erstellt wurden, zu löschen oder zu vernichten.

11.5) Die gewerblichen und/oder geistigen Eigentumsrechte, einschließlich des damit verbundenen Know-hows, sowie alle Ergebnisse, die Gegenstand privater Rechte sein können, die von FABAS ausgearbeitet, geliefert, in die Waren eingebaut/eingebaut oder in jedem Fall dem Käufer mitgeteilt wurden, sind und bleiben das ausschließliche Eigentum von FABAS.

11.6) Über die Verarbeitung personenbezogener Daten gemäß der Gesetzesverordnung Nr. 196/2003 (in der geänderten und ergänzten Fassung) und der EU-Verordnung 679/2016 (in der geänderten und ergänzten Fassung) haben sich die Parteien gegenseitig informiert und autorisiert und erklären, sich der Rechte bewusst zu sein, die sich aus den vorgenannten gesetzlichen Bestimmungen in Bezug auf die mit der Durchführung des vorliegenden Vertragsverhältnisses verbundenen Leistungen ergeben.

12. Rechtswahl und Gerichtsstand

12.1) Die vorliegenden allgemeinen Verkaufsbedingungen und die einzelnen Lieferbeziehungen unterliegen dem italienischen Recht. Die Anwendung des "Wiener Übereinkommens von 1980 über den internationalen Warenkauf" und anderer Konventionen, Vorschriften oder Regeln des internationalen Rechts über den Verkauf von Waren und/oder die Lieferung (auch von Dienstleistungen) ist ausgeschlossen.

12.2) Für sämtliche Streitfälle, die sich aus der Auslegung oder Durchführung dieses Vertragsverhältnisses ergeben, ist ausschließlich das Gericht von Monza (Italien) zuständig.

notes

FABAS LUCE S.p.A.
sede

Via Luigi Talamoni, 75
20861 Brugherio (MB) Italy
Tel. 0039 039 890 69 1
0039 039 214 22 06
Fax 0039 039 214 22 08
www.fabasluce.it
info@fabasluce.it
venditefabas@fabasluce.it
salesdept@fabasluce.it



FABAS LUCE GmbH

Westring, 5
D-59759 Arnsberg Germany
Tel. 0049 29 32 / 8 90 16 60
Fax 0049 29 32 / 8 90 16 62
vertrieb@fabasluce.com



© DITRE IDEAS MAKERS

graphic artwork & photo editing
Ditre.com

photo
Quasarfoto.com
Unsplash.com
Pages: 33-38-43-44-49-54-62-66-69-182
185-186-218-220-268-271-282-334-338
340-345-346-351-354-376-402-420-424-432

printed in Italy
August 2024

È VIETATA LA RIPRODUZIONE ANCHE
PARZIALE DI QUESTO CATALOGO.
IT IS FORBIDDEN TO REPRODUCE
ANY PART OF THIS CATALOGUE.

www.fabaslucce.it

